



JDC Line 1000

User Manual



Rev. 20240618-01 – Firmware v. 1.0.0



Document revisions

Revision number	Notes	Date released
20240618-01	Corrected error on page 63: channels 93 and 94 corrected to 98 and 99.	June 2024
20240416-01	Added Spread FX (offsets from fixture to fixture) to the flash effect on the Shutter mode DMX channel. Firmware v. 1.0.0	April 2024
20231107-01	Corrected fixture overview drawing page 7 Firmware v. 1.0.0	November 2023
20220317-01	First User Manual revision available Firmware v. 1.0.0	March 2022

GLP® JDC Line 1000 User Manual

© 2020-2024 German Light Products GmbH. All rights reserved.

The marks 'GLP' and 'German Light Products' are trademarks registered as the property of German Light Products GmbH in Germany, in the United States of America and in other countries.

The information contained in this document is subject to change without notice. German Light Products GmbH and all affiliated companies disclaim liability for any injury, damage, direct or indirect loss, consequential or economic loss or any other loss occasioned by the use of, inability to use or reliance on the information contained in this document.

Manufacturer's head office:

German Light Products GmbH (GLP), Industriestrasse 2, 76307 Karlsbad, Germany
Tel (Germany): +49 7248 92719 - 0

Service & Support EMEA:

GLP, Industriestrasse 2, 76307 Karlsbad, Germany
Tel. (Germany): +49 7248 9271955
Email: support@glp.de
www.glp.de

Service & Support USA:

GLP USA, 16170 Stagg St., Van Nuys, CA 91340
Tel (USA): +1 818 767 8899
Support (US): info@germanlightproducts.com
www.germanlightproducts.com

Table of Contents

1. Safety.....	4
Key to symbols.....	4
GLP Service and Support	5
2. JDC Line 1000 overview	6
3. Features.....	7
Fixture setup.....	8
Sections A and B	8
Strobe effects	8
Individual Cell Control.....	8
Shutter / intensity effects.....	9
Background Color	9
Dimming.....	10
Duration	10
Rate	11
Flash style	11
White point	11
CTC	11
Pixel mirror.....	11
No-signal behavior	12
Fan Mode	12
PWM frequency	13
Display mode	14
Display orientation	14
Custom settings presets.....	14
Fixture information	14
Manual control.....	15
Custom settings and reloading factory defaults	15
Service.....	15
4. Control menus and onboard display	16
Quick menu	17
Quick access options	17
5. Setting up the control protocol.....	18
6. Control menu layout	20
Quick menu	24
7. DMX control modes overview	25
8. DMX control channel layout.....	38
DMX Mode 1: RGBW Strobe	39
DMX Mode 2: W Strobe + RGB Strobe	41
DMX Mode 3: W Strobe + RGB Pixel	47
DMX Mode 4: White + RGB Strobes + W Pixel.....	52
DMX Mode 5: Multipix	57
DMX Mode 6: Multipix Advanced	61
DMX Mode 7: Multipix Quadpix	65
Control / Settings channel.....	70

1. Safety

Key to symbols

The following symbols are used in the JDC Line 1000 lighting fixture's user documentation:



Warning! Safety hazard.
Risk of severe injury or death.



Warning! Hazardous voltage.
Risk of lethal or severe electric shock.



Warning! See user manual for important safety information.



Warning! Fire hazard.



Warning! Risk of eye injury.



Warning! Read the JDC Line 1000 Quick Start and Safety Manual supplied with the fixture and available for download from www.glp.de before installing, operating or servicing the fixture. The Quick Start and Safety Manual contains important information for the safe use of JDC Line 1000 fixtures. If you fail to read that information you may create a safety hazard with a risk of injury, death or damage.

If you have any doubts or questions about how to use the GLP® JDC Line 1000 lighting fixture safely, contact your GLP supplier for assistance. Your GLP supplier will be happy to help.

The user documentation for JDC Line 1000 fixtures consists of three documents:

- The **JDC Line 1000 Quick Start and Safety Manual**, supplied with JDC Line 1000 fixtures and available for download from www.glp.de. The Quick Start and Safety Manual contains important safety information and installation instructions that the installer and user must read. It also contains dimensions drawings and technical specifications for the fixture.
- The **JDC Line 1000 User Manual**, available for download from www.glp.de. The User Manual explains features and control of JDC Line 1000 fixtures.
- The **JDC Line 1000 DMX Channel Index**, available for download from www.glp.de. The Channel Index is a separate document containing the DMX control channel layout and DMX commands available in the fixture. This information is also included in the User Manual.

The JDC Line 1000 is intended for use by experienced professionals with the knowledge and skills to set up, operate, and maintain high-powered, remotely controlled lighting

equipment safely and efficiently. These operations require expertise that may not be provided in this manual.

- Respect all warnings and directions given in the fixture's user documentation and on the fixture. Read the fixture's Quick Start and Safety Manual and familiarize yourself with the safety precautions it contains before installing, using or servicing the fixture. GLP and affiliated companies will take no responsibility for damage or injury resulting from disregard for the information in the user documentation.
- Check the GLP website at www.glp.de and make sure that you have the latest versions of the fixture's Quick Start and Safety Manual and this user manual.
- Check the fixture software version indicated on page 2 of this user manual and then use the fixture's control panel to check the version installed in the fixture. If the versions are not the same, the user manual may still cover the fixture, because software updates do not always affect the use of the fixture. However, it is possible that this manual does not match the fixture perfectly. Software release notes can help clarify this question. You can consult software release notes and download the correct version of this user manual on the GLP website if necessary.
- Make both the Quick Start and Safety Manual and this user manual available to all persons who will install, operate or service the fixture. Save both documents for future reference.
- If you have any questions about the safe operation of the fixture, please contact an authorized GLP distributor (see list of distributors at www.glp.de).

GLP Service and Support

Contact information for the nearest GLP Service and Support is available online at www.glp.de/en/service, by email at info@glp.de, or by telephone at the following numbers:

- GLP Germany: +49 (7248) 927 19-55
- GLP N. America: +1 818 767-8899
- GLP UK: +44 1392 690140
- GLP Asia: +852 (3151) 7730
- GLP Nordic: +46 737 57 11 40

2. JDC Line 1000 overview

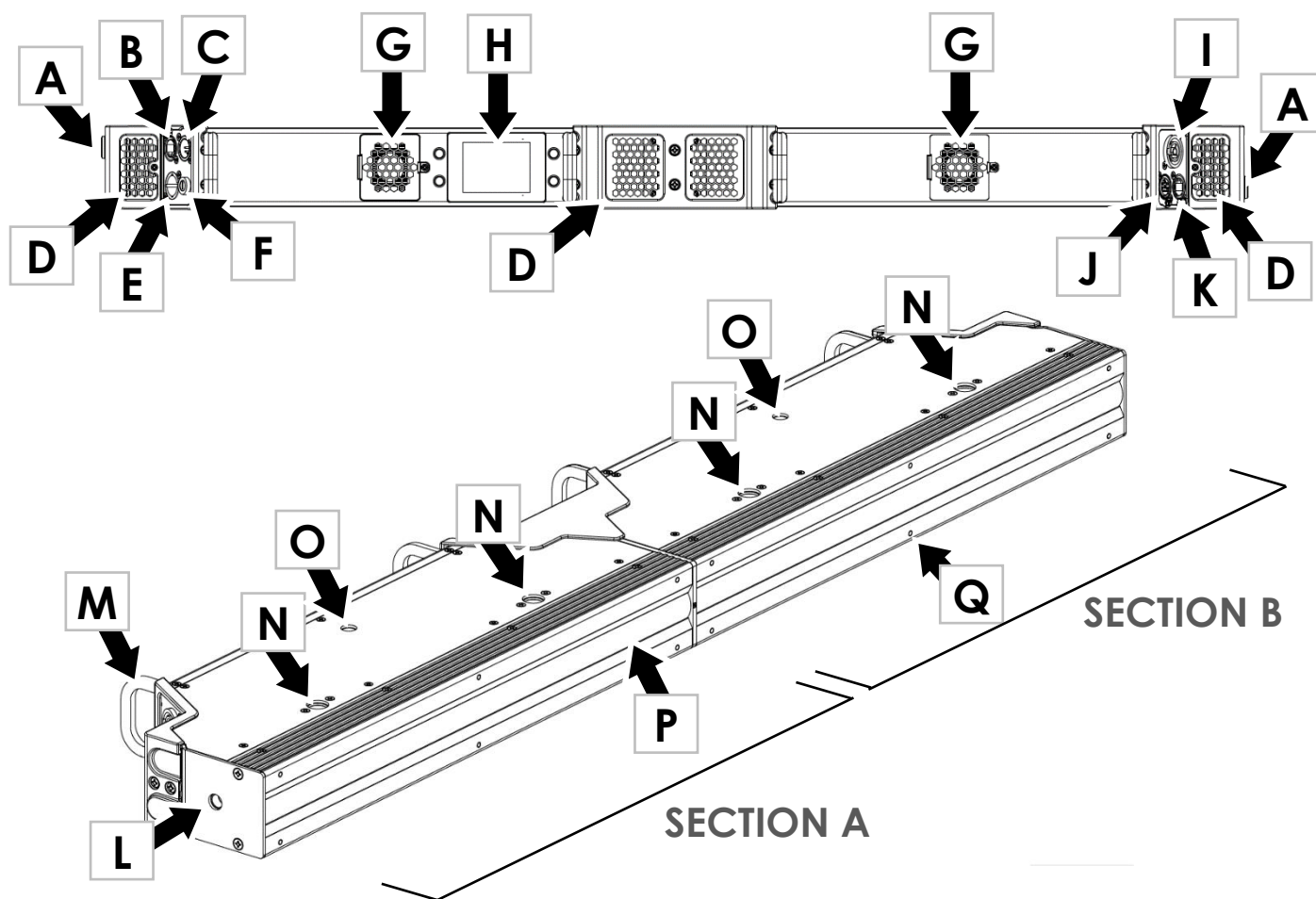

Figure 1. JDC Line 1000 overview

- | | |
|---|---|
| <ul style="list-style-type: none"> A – End bracket / side-to-side alignment points B – Network port A (EtherCON), failsafe) C – DMX IN (5-pin XLR) D – Air vents E – AC mains power IN (Neutrik powerCON TRUE1) F – Fuseholder G – Main cooling fans H – Control panel with multi-color backlit LED display I – AC mains power OUT/THRU (Neutrik powerCON TRUE1) | <ul style="list-style-type: none"> J – DMX THRU/OUT (5-pin XLR) K – Network port B (EtherCON), failsafe L – 2 x end mounting points (M10 threaded, depth 16 mm) M – 4 x safety cable attachment points / carrying handles N – 4 x quarter-turn fastener points O – 2 x top / bottom mounting points (M10 threaded, depth 16 mm) P – White LEDs, RGB LEDs Q – 12 x M4 threaded holes for permanent mounting of accessories |
|---|---|

3. Features

The JDC Line 1000 from GLP® is a powerful LED-based strobe/color effect linear lighting fixture. It combines a powerful strobe line with RGB and white pixel mapping in one device.

The JDC Line 1000 is twice the length and has twice the performance of GLP's JDC Line 500. The JDC Line 1000 has the advantage that it only requires one power connection, one data connection and one control panel to run 1000 mm of JDC Line pixels. Internally, the JDC Line 1000 has two separate strobe and effect engines, which lets you operate it as if it was two separate 500 mm fixtures.

The DMX channel layout of the JDC Line 1000 is based on the layout of 2 x JDC Line 500s. This means that you can simply patch two JDC Line 500s next to each other to control one JDC Line 1000. The *Control / Settings* channel of the second patched fixture is ignored – the JDC Line 1000 uses the *Control / Settings* channel of the first patched fixture only.

It features:

- Two sections, **A** and **B**, that can be controlled as if they were two JDC Line 500 fixtures.
- Easy integration with the JDC Line 500: one JDC Line 1000 fixture maps onto two JDC Line 500 fixtures in an existing DMX control setup.
- 2 x 20 super-bright White 25 mm strobe segments
- 2 x 40 super-bright 25 mm RGB segments
- RGB segments can be split into two (80 segments total) for even more zig-zag effects
- White, RGBW and RGB strobes
- White and RGB pixel mapping, White strobe over RGB pixel mapping, and RGB strobe over White pixel mapping
- RGBW background channels with separate dimmer for continuous ambient light
- Powerful FX engines with a range of pre-programmed pixel patterns
- Interlocking design that allows almost gapless installation of multiple fixtures
- Rear airflow design that lets you stack fixtures on top of each other or place them directly on the ground
- Ease of installation with smart, flexible rigging and mounting options
- Control panel with new backlit multicolor LED display
- Quarter-turn locking points for omega clamps and end-to-end fastener bars

The JDC Line 1000 features a central tube of 200 x powerful White LEDs in 40 segments across its Sections A and B. The white LEDs provide impressive strobe effects and pixel mapping. Above and below the White LEDs are 400 x RGB LEDs in two rows that can be controlled as 20, 40, 60 or 80 segments. The RGB LEDs also provide strobe effects and pixel mapping.

A range of pre-programmed dynamic FX patterns with variable parameters can be selected and run on the White and RGB segments.

The JDC Line 1000 can be used indoors in permanent and temporary installations. It can be placed horizontally on a level surface, suspended from a suitable rigging structure or mounted on a structure or surface as described in the fixture's Quick Start and Installation Manual.

Fixtures can be interlocked in lines, and power and data can be daisy-chained for ease of installation.

A magnetic system lets you mount optical accessories from GLP on the front of the fixture in seconds. Six M4 threaded holes on Section A and six on Section B are provided for more permanent installation of optical accessories.

The JDC Line 1000 is not suitable for household use, for use in any location where unattended children have access to it, or for use in permanent outdoor installations.

Fixture setup

The JDC Line 1000 has an onboard control panel with a graphic display (see 'Control menus and onboard display' on page 16) that you can use to configure the fixture's settings. You can also access all the fixture's important settings remotely via DMX on the fixture's *Control / Settings* channel (DMX channel 6 in all DMX modes).

Sections A and B

The JDC Line 1000 can be controlled as if it was two separate JDC Line 500 fixtures that make up two halves of the JDC Line 1000. The two halves are controlled as **Section A** and **Section B**.

You can swap the positions of Section A and Section B in the Fixture Settings menu in the fixture's control panel, on the *Control / Settings* DMX channel, or via RDM.

Strobe effects

The JDC Line 1000 features RGBW strobe effects that you can run on all the fixture's LEDs together over a background with RGBW control. It also offers RGB and White strobe effects that you can run separately. Again, you can run White and RGB strobe effects over a background with RGBW control.

All strobe effects feature a powerful effects engine with pre-programmed patterns. You can snap between patterns and between steps in patterns, or you can crossfade with variable fade times.

Individual Cell Control

Some of the control modes provide individual control of the white or RGB segments.

On the JDC Line 1000 the line of powerful White LEDs can be split into 40 segments: 20 segments in Strobe A and 20 segments in Strobe B. The line of powerful RGB LEDs can also be split into 40 segments with the additional possibility of separating the top and bottom half of each segment to give individual control of 80 RGB pixels. The segments can be controlled like 2 x JDC Line 500s.

For normal pixel-mapping applications (MultiPix Mode) the upper and lower half of each RGB Segment are controlled at the same time. Advanced pixel-mapping mode (MultiPix Advanced Mode) allows individual control of the top and bottom part of the pixel.

RGB Pattern selection offers both segment patterns and split-segment patterns.

Shutter / intensity effects

The JDC Line 1000's electronic shutter effect provides single flash, pulse, opening pulse, closing pulse, random pulse, random opening pulse, random closing pulse, double flash, random double flash, triple flash, random triple flash, spike, lightning, random pixel flash and random fixture flash effects as well as instant blackout. From firmware v.1.0.0, you can apply an offset between the flash in different fixtures, making it easy to create flash chases.

Background Color

All control modes offer a set of RGBW channels with a separate dimmer called Background Color. By default, these channels should be set to 0% because they are not necessary for normal use of the fixture.

The Background Color channels let you add a low-priority background color, giving you the ability to set a continuous background color for ambient light in the set design, for example. You can add any of the fixture's other effects on top of the background color at any time.

Background Color works as in these two examples:

- No Background Color active - Background Color is set to 0%.

You can use the main fixture as normal, but all flash effects run on top of a "black" background. The intervals between flashes are black (off).

- Background Color active - Background Color is set to Blue 100%.

You can use the main fixture as normal, for example red flashes, but all flash effects run on top of a blue background. This gives red flashes with blue in-between the flashes.

Background color and main color mixing

You can define how the background color and the main fixture color are mixed. There are three options:

1. **Crossfade** (default) – the Background Color stays in the background and the main color has higher priority. If you fade in a main color, the background color will crossfade to the main color. For example, if you set a blue background color and then fade in continuous red on the main color channels you will obtain a crossfade from blue background to red main color.
2. **Mix** – the Background Color mixes with the main color. For example, if you set a blue background color and then run a red Flash on the main color channels, the result will be a magenta flash. The main color of the flash will mix with the background color.

3. **Override** – the Background Color stays in the background. The color displayed using the main channels has higher priority and will not mix with the background color. As soon the main color value is >0 the background color will black out and the main color will appear. For example, if you set a blue background color and then fade in continuous red on the main color channels, the blue will disappear completely and the red will fade up from zero intensity. The main red color will not mix or crossfade with the background blue color.

You can select the Crossfade, Mix or Override options in the **Fixture Settings** menu in the fixture's control panel, on the *Control / Settings* DMX channel, or via RDM.

Dimming

The Dimmer channels control the output of the fixture in 16-bit resolution. You can select from Linear or Soft dimming curves in the **Fixture Settings** menu in the fixture's control panel, on the *Control / Settings* DMX channel, or via RDM.

See Figure 2. The dimming curve options available are:

- **Linear** - the Linear setting gives a dimming curve that the eye perceives as linear. Intensity appears to increase and decrease evenly throughout the dimming range.
- **Soft** - The Soft (square law) setting gives finer control at lower light levels, where the eye is most sensitive to changes in light intensity, and coarser control at higher light levels. This is the default dimming curve setting.

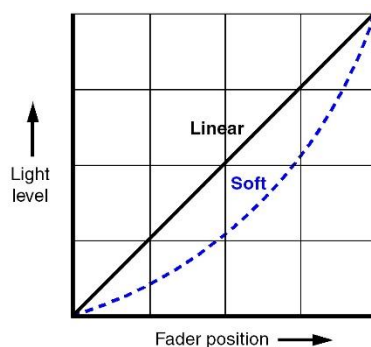

Figure 2. Dimming curves

Duration

The Flash Duration channel lets you adjust the length of flashes from super-short to long.

You can change the Duration style setting in the Fixture Settings menu in the fixture's control panel, on the *Control / Settings* DMX channel, or via RDM. Two different types of flash duration control are available:

- **Normal** control lets you vary the duration from short to long independently of the Flash Rate channel setting. This is the default flash duration setting.
- **Percentage** control lets you vary the duration as a percentage of the selected Flash Rate.

Rate

If no intensity effect is selected, the Flash Rate channel lets you adjust the interval between flashes:

- At DMX values from 000 to 004 the fixture will not flash.
- At DMX values from 251 to 255 the fixture will execute a continuous on.
- At DMX values from 005 to 250 the fixture will perform flashes with long intervals to super-short intervals between flashes.

If an intensity effect is selected, the Flash Rate channel lets you adjust the speed of the intensity effect.

Flash style

The JDC Line 1000 offers two types of LED behavior when operating as a strobe:

- **Normal** sets LEDs to light continuously during flashes at the PWM rate set using the control panel (the default rate is 3000 Hz). This is the default flash style setting.
- **Xenon** sets LEDs to mimic the high-frequency flicker during flashes that is characteristic of xenon tube strobe lights.

You can change the Flash style setting in the **Fixture Settings** menu in the fixture's control panel, on the *Control / Settings* DMX channel, or via RDM.

White point

This setting lets you select the white point obtained when RGB is set to 100% and obtain a clean white light with fixed white point when opening the fixture's shutter without adjusting RGB color or programming color presets. The following color temperatures are available as fixed white points: **8000 K**, **6500 K** and **5600 K**. The default setting is **6500 K**.

Setting White point to **Off** disables this feature and puts RGB control into raw mode.

You can change the White point setting in the **Fixture Settings** menu in the fixture's control panel, on the *Control / Settings* DMX channel, or via RDM.

CTC

Using the CTC (Color Temperature Correction) channel lets you temporarily leave the fixed white point of the fixture and change it within a color temperature range of 10 000 K to 2 500 K.

Note that RGB needs to be set to 100% to mix pure white. Decreasing RGB values will modify the color relative to the chosen CTC white point.

Pixel mirror

To achieve symmetrical effects in multiple installations or co-ordinate effects when fixtures are not oriented identically, the JDC Line 1000 lets you quickly reverse and/or invert the order of the pixels in each section, A and B:

- **Off** gives normal pixel layout (see Figure 3). Pixel 01 is at the Power OUT/THRU end of the fixture, on the left when facing the fixture with the fixture oriented normally. This is the default pixel layout setting.

RGB Upper	01	02	03	04	05	06	07	08	09	10	11	12	13	14	15	16	17	18	19	20
White	01	02	03	04	05	06	07	08	09	10	11	12	13	14	15	16	17	18	19	20
RGB Lower	21	22	23	24	25	26	27	28	29	30	31	32	33	34	35	36	37	38	39	40

Figure 3. Normal pixel layout in Section A (identical in Section B)

- **X-mirror** reverses the order of the pixels so that they run from right to left. In this configuration, Pixel 01 is at the Power IN end of the fixture, on the right when facing the fixture with the fixture oriented normally.
- **Y-mirror** inverts the RGB pixel rows so that the pixels run from left to right but pixels 11 to 20 move to the top row and pixels 1 to 10 move to the bottom row of the fixture. *Top and bottom are relative to the control panel display when the display orientation is set to Normal.*
- **X-Y-mirror** reverses the order of the pixels and inverts the RGB pixel rows at the same time.

You can change the Pixel mirror setting on the *Control / Settings* DMX channel, in the **Fixture Settings** menu in the fixture's control panel.

No-signal behavior

You can decide how the fixture should behave if it is not receiving a DMX signal (if the fixture is being controlled by DMX but the DMX signal stops, or if you apply power to the fixture when no DMX signal is present). Three options are available:

- **Blackout** – The fixture goes to dead blackout. This is the default setting.
- **Hold** – The fixture holds the last DMX values that it received.
- **Houselight** – The fixture switches to the maximum light level that can be displayed continuously.

These settings are available on the *Control / Settings* DMX channel, in the **Fixture Settings** menu in the fixture's control panel, or via RDM.

To avoid any possibility of unexpected behavior from a powerful strobe light if the DMX signal fails, we recommend that you always set the fixture to **Blackout** or **Houselight**.

Fan Mode

The Fan Mode setting gives different options for the fixture's cooling fan operation and temperature management. Having options to choose from can be very helpful if you are operating the fixture in a very hot or noise-sensitive environment. Four options are available:

- **Regulated** – gives priority to light output and only operates fans as necessary. If the fixture is blacked out, fans run at minimum speed. When light output intensity is increased, temperature regulation increases fan speed to the level necessary to keep the fixture at optimum temperature.

If light output is set to maximum intensity but the fans can keep the fixture at optimum temperature, there will be no regulation of light intensity. If the fixture begins to exceed optimum temperature and fans are running at maximum speed it will begin to limit light intensity until optimum temperature can be maintained.

Regulated is the default fan mode setting.

- **High** – lets the fixture operate at maximum light output and suits operation in high ambient temperatures. Fans are set to constant operation at high speed. Light output intensity is limited smoothly if it becomes necessary in order to keep fixture temperature at optimum temperature level.

Besides maximizing light output in high ambient temperatures, you can use the **High** mode to cool down a fixture quickly or to remove dust from cooling fans.

- **Medium** – sets fans to constant operation at medium speed. Light output intensity is reduced to a level where it will normally remain constant at ambient temperatures of up to 45° C (113° F). Intensity is smoothly limited further if it becomes necessary in order to keep fixture temperature at optimum temperature level.
- **Low** – sets fans to constant operation at low speed and is optimized for minimum noise. Light output intensity is reduced to a level where it will normally remain constant at ambient temperatures of up to 30° C (86° F). Intensity is smoothly limited further if it becomes necessary in order to keep fixture temperature at optimum temperature level.

In all fan modes, if fixture temperature reaches a dangerous level, LEDs will be shut down for a period until the fans have brought the temperature down to a safe level.

PWM frequency

You can change the LED dimming PWM frequency in order to avoid flicker and beat frequencies in video images. To do this, select a new PWM frequency using either the *Control / Settings* DMX channel, the **Fixture Settings** menu in the fixture's control panel or RDM.

The default PWM setting is 3000 Hz. You can set the PWM frequency to 2700 Hz, 3000 Hz, 4800 Hz or 9600 Hz. Note that a higher PWM frequency may affect dimming performance.

The PWM frequency setting is stored in the fixture and is not affected by cycling power off and on. However, it will be reset to the default frequency if you apply a **Fixture Settings → Load Settings → Default** command or a **Service → Advanced → Load Factory Backup** command in the control menus.

As a rule, you should set all the fixtures in an installation to the same PWM frequency in order to ensure the same performance.

Display mode

You can choose between three different modes for the control panel display:

- **Auto:** The display will automatically switch off after a few seconds if the fixture is receiving a valid control signal and has not detected an error. If the fixture is not receiving a valid control signal the display will flash. If the fixture has detected an error, the display will remain constantly on and show the error. This is the default setting.
- **On:** The display stays on constantly. This setting can be useful when you are configuring or servicing the fixture.
- **Off:** The display will automatically switch off after a few seconds even if the fixture is not receiving a valid control signal or if it has detected an error.

You can change the Display mode setting on the *Control / Settings* DMX channel, in the **Fixture Settings** menu in the fixture's control panel, or via RDM.

Display orientation

Depending on which way up you install the fixture, you can change the orientation of the control panel display:

- **Auto:** The readout in the display is automatically turned through 180° if the fixture is installed upside-down. This is the default setting.
- **Normal:** The readout in the display is the right way up when the fixture is placed with the display closer to the right-hand end of the fixture, close to the Mains Power OUT/THRU connector, as shown in Figure 1 on page 6.
- **Inverted:** The readout in the display is turned through 180°.

You can change the Display orientation setting on the *Control / Settings* DMX channel, in the **Fixture Settings** menu in the fixture's control panel, or via RDM.

Custom settings presets

The JDC Line 1000 sets you set up three different fixture configurations and save them as custom presets. A configuration includes all of the fixture's personality settings (dimming curve, pixel orientation etc.) but does not include DMX address, DMX mode and control protocol type.

Calling up a preset let you quickly recall configurations that you have set up in advance to match different uses or different environments.

You can save custom presets and load custom presets via DMX on the *Control / Settings* DMX channel. You can also save custom presets in the **Service → Advanced → Save Settings** menu and load custom presets in the **Fixture Settings** menu in the fixture's control panel.

Fixture information

The **Information** menu in the control panel gives access to items of information from the fixture's sensors and memory. You can check temperature sensor readouts, see total operating hours counters and power cycle count, and see DMX signal quality data, for example.

Manual control

If the JDC Line 1000 is connected to mains power, you can control it without using a DMX controller if you open the **Manual Control** menu in the control panel.

This menu also lets you reboot the fixture.

If the fixture is connected to a DMX controller, it is also possible to take a snapshot of all the DMX values that the fixture is receiving using a **Capture DMX Values** command. These values are then applied as manual control values and stored in memory. Each time that you enter the **Manual DMX** menu, the fixture will use these values until you adjust them or apply a **Reset Manual Values** command.

Custom settings and reloading factory defaults

Custom settings are stored after a power off/on cycle and after a reset.

Two options are available in the fixture's control panel for deleting multiple custom settings and restoring defaults:

- **Fixture Settings → Load Settings → Default** reloads all the fixture's factory default settings **except** DMX address, DMX mode and Control protocol. This option returns the fixture to baseline settings (Normal pixel orientation, Linear dimming curve, etc.) without affecting its basic configuration in an installation.
- **Service → Advanced → Load Factory Backup** reloads all the fixture's factory default settings **including** DMX address, DMX mode and Control Protocol. This option reinitializes the fixture completely and returns to its state when it left the factory.

Service

The **Service** menu is split into two levels: **Service** and **Service Advanced**.

The **Service Advanced** level is for trained technicians only. Read the User Manual carefully before entering this level.

Test Sequences

This menu lets you run different test sequences in order to quickly check the product for correct operation.

Reset Counters

The commands in this menu let you reset the fixture's user resettable counters.

Note that device counters are not reset if you execute a Load Factory Backup command.

4. Control menus and onboard display



Warning! DMX control is disabled when the control menus are active. Be prepared for the fixture to emit strong light as soon as you exit the control menus.

The control panel and onboard backlit LED display provide access to user settings, readouts and utilities.

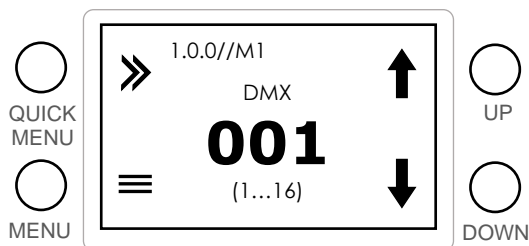

Figure 5. Default screen

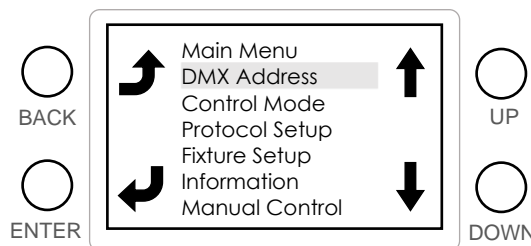

Figure 4. Main menu

The functions of the control buttons depend on which screen is open in the control panel display. The functions are indicated by icons:

BOTTOM-LEFT BUTTON (MENU / ENTER)

When the display is in sleep mode, the bottom-left MENU / ENTER button activates the display and calls up the default screen (see Figure 5) that gives the following information:

- Firmware version // DMX Mode
- Protocol type (DMX, Art-Net, sACN)
- DMX address
- DMX channel footprint.

When the default screen is active, the MENU / ENTER button opens the main menu (see Figure 4).

When navigating in the menus, the MENU / ENTER button confirms a selection, enters a sub-menu or implements a command.

TOP-LEFT BUTTON (QUICK MENU / BACK)

When the default screen is active, the QUICK MENU / BACK button opens the quick menu.

When navigating in the menus, the QUICK MENU / BACK button navigates back one level towards the top of the menu.

TOP-RIGHT BUTTON (UP)

Scroll up through a menu or increase a number.

BOTTOM-RIGHT BUTTON (DOWN)

Scroll down through a menu or decrease a number.

When you apply power to the fixture it takes a few seconds to boot. After it has booted, the panel displays the default screen.

DMX control is disabled when the control menus are active.

A number of options for customizing the onboard display are available on the *DMX Control / Settings* channel and in the *Display* control menu in the control panel.

Quick menu

A quick menu is provided to save time. To open the quick menu, activate the default screen by pressing the MENU button and then press the ENTER button ».

The quick menu gives you the following options:

- Toggle the display orientation between auto, normal and inverted.
- Reboot the fixture.
- Load any of the three custom setting presets that have been saved previously or load the factory default settings.
- Reinitialize the fixture by returning all settings to factory defaults, deleting all custom presets, returning all resettable counters to zero, setting the fixture's DMX address to 1 and setting the DMX Mode to the factory default (Mode 2: W Strobe + RGB Strobe).

Quick access options

When the fixture is connected to mains power and has booted normally, the following functions can be accessed quickly by pressing key combinations.

- Holding UP and DOWN pressed together for less than one second toggles the display orientation.
- Pressing UP or DOWN three times calls up a readout of the main fixture information and the fixture's settings.

Battery Eco mode

When the fixture is not connected to mains power and is running on its internal battery, holding MENU and ENTER pressed in together for 10 seconds activates *Battery Eco Mode*. This disables battery power to protect the battery from being run flat if the fixture is accidentally switched on during transportation.

Put the fixture into *Battery Eco Mode* before transportation or long-term storage.

To take the fixture out of *Battery Eco Mode*, simply connect it to power.

5. Setting up the control protocol

The JDC Line 1000 can be controlled via USITT512 DMX over a standard DMX cable link using the fixture's 5-pin XLR connectors or via Art-Net or sACN over network cable using the fixture's Ethernet port. This section explains how to configure the fixture to use the control data protocol that it is connected to.

The fixture is set up for control via a standard DMX cable link by default.

DMX

To configure the fixture to receive DMX control data over a standard DMX cable link, open the menus in the fixture's control panel and make the following adjustments:

1. In the first menu (root menu), give a suitable DMX address to the fixture.
2. In the **Protocol Setup** → **Protocol Type** menu, set the control protocol to **DMX** (the default setting).

These settings will not be affected if you apply a **Load Settings** command in the fixture's control panel, but the DMX address will be returned to 1 (the factory default) if you apply a **Load Factory Backup** command in the fixture's control panel.

Art-Net

To configure the fixture to receive DMX control data via Art-Net, open the menus in the fixture's control panel and make the following adjustments:

3. In the first menu (root menu), give a suitable DMX address to the fixture.
4. In the **Protocol Setup** → **Protocol Type** menu, set the control protocol to **Art-Net**.
5. Give all fixtures their own unique IP addresses. To do this, you can either:
 - set fixtures to generate their own IP addresses by choosing the ranges 2.x.x.x or 10.x.x.x (Art-Net specification),
 - set fixtures to acquire IP addresses automatically by DHCP, or
 - assign IP addresses manually by entering individual IP addresses and Subnet mask.
6. Select an Art-Net port/universe from 00000 (Network 0 / Subnet 0 / Universe 0) to 32767 (Network 7 / Subnet 15 / Universe 255). Note that the first Art-Net universe is considered to be universe number 00000, not 00001.

These settings will not be affected if you apply a **Load Default Settings** command in the fixture's control panel, but they will be returned to factory defaults if you apply a **Load Factory Backup** command in the fixture's control panel.

Note that it is possible to transmit DMX data as broadcast or unicast packages via Art-Net. If a large number of universes (more than 30) is broadcast, data loss can occur. If you suspect that this is happening, configure your console to unicast Art-Net DMX packages to fixtures, or switch to sACN.

sACN

To configure the fixture to receive DMX control data via sACN, open the menus in the fixture's control panel and make the following settings:

1. In the first menu (root menu), give a suitable DMX address to the fixture.
2. In the **Protocol Setup** → **Protocol Type** menu, set the control protocol to **sACN**.
3. Give all fixtures their own unique IP addresses. To do this, you can either:
 - set fixtures to generate their own IP addresses by choosing the ranges 2.x.x.x or 10.x.x.x (Art-Net specification),
 - set fixtures to acquire IP addresses automatically by DHCP, or
 - assign IP addresses manually by entering individual IP addresses and Subnet mask.
4. Select an sACN universe from 00001 to 63999.

These settings will not be affected if you apply a **Load Default Settings** command in the fixture's control panel, but they will be returned to factory defaults if you apply a **Load Factory Backup** command in the fixture's control panel.

6. Control menu layout

Menus		Notes	
DMX Address			
1 - 512		Enter DMX address	
Control Mode			
M1 - RGBW Strobe (CH32)		Select DMX control mode	
M2 - WStrobe + RGBStrobe (CH68)			
M3 - WStrobe + RGBPixel (CH168)			
M4 - RGBStrobe + WPixel (CH94)			
M5 - MultiPix (CH196)			
M6 - MultiPix Advanced (CH316)			
M7 - MultiPix Quadpix (CH76)			
Protocol Setup			
Protocol type	DMX	Control via DMX protocol	
	ArtNet	Control via Art-Net protocol	
	sACN	Control via sACN protocol	
Ethernet Config	Addressing Mode	Auto 2.X.X.X	Auto addressing in the range 2.X.X.X
		Auto 10.X.X.X	Auto addressing in the range 10.X.X.X
		Static IP	Uses custom IP address and custom subnet mask (set these in next menu)
		DHCP	Gets IP address by DHCP
	Custom IP Address	xxx.xxx.xxx.xxx	Enter custom IP address
	Custom IP Subnet	xxx.xxx.xxx.xxx	Enter custom subnet mask
	ArtNet Port	0 - 32768	Sets which port listens for sACN packets
	sACN Universe	1 - 63999	Sets ACN universe
Fixture Settings			
Dimmer Curve	Linear	Select dimming curve	
	Soft		
Flash Style	Normal	Normal strobe	
	Xenon	Simulated xenon flicker strobe	
White point	8000	Sets white point to 8000 K	
	6500	Sets white point to 6500 K	
	5600	Sets white point to 5600 K	
	Off (RAW)	All RGB at full power - no specific White color temperature	



Pixel Mirror	Off	Normal pixel order: 1 to 10 (Pixel 1 is at Power IN)
	x-mirror	Reversed pixel order: 10 to 1 (Pixel 1 is at Power OUT)
	y-mirror	Inverted pixel order (Pixel 11 to 20 on top row)
	x-y-mirror	Reversed and inverted pixel order (Pixel 20 to 11 on top row)
	Pixel Mirror: x-mirror (A only)	Reversed pixel order: First pixel = bottom row left, last pixel is top row left, viewed from front (applies to Section A only)
	Pixel Mirror: y-mirror (A only)	Inverted pixel order: First pixel = top row right, last pixel = bottom row left, viewed from front (applies to Section A only)
	Pixel Mirror: x-y-mirror (A only)	Reversed and inverted pixel order: First pixel = bottom row right, last pixel is top row left, viewed from front (applies to Section A only)
	Pixel Mirror: x-mirror (B only)	Reversed pixel order: First pixel = bottom row left, last pixel is top row left, viewed from front (applies to Section B only)
	Pixel Mirror: y-mirror (B only)	Inverted pixel order: First pixel = top row right, last pixel = bottom row left, viewed from front (applies to Section B only)
	Pixel Mirror: x-y-mirror (B only)	Reversed and inverted pixel order: First pixel = bottom row right, last pixel is top row left, viewed from front (applies to Section B only)
Fixture Order	Normal	Section A is at Power IN end of fixture, Section B is at Power OUT
	Reversed	Section A is at Power OUT end of fixture, Section B is at Power IN
Background Color	Crossfade	Crossfading from background color to main color
	Mix	Main color mixes with background color
	Override	Main color completely overrides background color
No Signal	Blackout	If DMX signal absent, fixture blacks out
	Hold	If DMX signal absent, fixture holds last DMX values received
	Houselight	If DMX signal absent, fixture goes to constant white light
Fan Mode	Regulated	Fan speed regulated
	High	Fans run at constant high speed, output reduced if necessary
	Medium	Fans run at constant medium speed, output reduced if necessary
	Low	Fans run at constant low speed, output reduced if necessary

PWM Frequency	2700 Hz		Sets LED refresh rate
	3000 Hz		
	4800 Hz		
	9600 Hz		
Display Mode	Auto		Control panel display enters sleep mode after short period. An error will cause the display to light up.
	On		Display constantly on
	Off		Display constantly off. An error will not cause the display to light up.
Display Orientation	Auto		Control panel display automatically inverts if fixture is inverted
	Normal		Display normal
	Inverted		Display inverted down to up
Load Settings	Preset 1	>>>>Confirm<<<<	Loads custom settings and custom offsets. Must be confirmed.
	Preset 2	>>>>Confirm<<<<	
	Preset 3	>>>>Confirm<<<<	
	Default	>>>>Confirm<<<<	Loads factory default settings and offsets
Information			
Live diagnostic (due to be implemented in next SW update)			Calls up an overview of all main fixture information, signal quality and settings.
Show Errorlist			Shows last and current errors
Show Serial Number			Shows fixture's serial number
Show SW version			Shows current software version
Show device info			Shows fixture information
Show device hours			Shows resettable and non-resettable counters
Device Power Cycles			Shows resettable and non-resettable power cycle counters
Show DMX Input			Shows DMX values received for all functions
Show Signal Quality			Shows signal quality (framerate, noise, etc.)
Show Temperature			Shows temperatures in °C & °F
Show Fan Monitor			Shows fan rpm and Voltage



Manual Control			
Reboot (confirm 3 sec.)		Reboots fixture	
Manual DMX <i>(applies to both Strobe A and Strobe B)</i>	Intensity coarse (RGBW)	000 - 255	Manual fixture control
	Intensity fine (RGBW)	000 - 255	
	Duration (RGBW)	000 - 255	
	Rate (Shutter) (RGBW)	000 - 255	
	Intensity Effects [Strobe Mode] (RGBW)	000 - 255	
	CTC	000 - 255	
	R	000 - 255	
	G	000 - 255	
	B	000 - 255	
	W	000 - 255	
Reset Manual values (confirm 3 sec.)		Resets all manual DMX values to default	
Service			
Test All	Confirm	<i>Runs continuous test sequence: pan & tilt first, then all FX with head straight up. Stop test by pressing "Back" button.</i>	
Test White	Confirm	<i>Runs continuous test sequence on White LEDs. Stop test by pressing "Back" button.</i>	
Test RGB	Confirm	<i>Runs continuous test sequence on RGB LEDs. Stop test by pressing "Back" button.</i>	
Advanced (Press and hold Enter for 3 sec. to confirm)	Reset Counters	Device Hours (confirm 3 sec.)	Returns resettable counter to zero
		Device Power Cycles (confirm 3 sec.)	
		Max Temperatures (confirm 3 sec.)	
	Save Settings	Preset 1 (confirm 3 sec.)	Saves all custom settings including offsets as a preset (must be confirmed)
		Preset 2 (confirm 3 sec.)	
Preset 3 (confirm 3 sec.)			
Load Factory Defaults			
CONFIRM	Fixture may lose connection to the controller! >>>>Confirm<<<<	<i>Loads factory default settings and sets all fixture configuration settings to default</i>	

Default settings are written in **BOLD type**.

Quick menu

To open the quick menu, press the ENTER button: [>>] symbol

Menus		Notes
Display Orientation	Auto	Display automatically inverts if fixture is inverted
	Normal	Display normal
	Inverted	Display inverted down to up
Fixture Order	Normal	Section A is at Power IN end of fixture, Section B is at Power OUT
	Reversed	Section A is at Power OUT end of fixture, Section B is at Power IN
Reset	Confirm	Reboots fixture
Live diagnostic (due to be implemented in next software update)		Calls up an overview of all main fixture information, signal quality and settings.
Show errors		Shows any errors detected. Use UP and DOWN buttons to scroll through list
Load Settings	Preset 1	>>>>Confirm<<<<
	Preset 2	>>>>Confirm<<<<
	Preset 3	>>>>Confirm<<<<
	Default	>>>>Confirm<<<<
Load Factory Backup (!) – confirm for 5 sec.		Loads factory default settings, resets custom offsets, deletes customer presets, sets resettable counters to zero, sets DMX address to 1, sets DMX mode to default (Mode 2: WStrobe + RGBStrobe)

7. DMX control modes overview

The following DMX control modes are available in the JDC Line 1000.

DMX Mode 1: RGBW Strobe

32 DMX Channels

RGBW strobe is a global strobe that uses all the White and all the RGB segments on Section A and on Section B together. This global strobe runs independently on each Strobe section. Each strobe has flash, pulse and ramp-up/down effects as well as special intensity effects such as lightning. The strobes offer RGBW control plus separate color temperature control that defines each section's white point.

Background color sets a background color on the RGB segments for Section A and B independently. As standard, the main color output always has higher priority than the background color.

You can define how background color and main color are mixed on both Strobes using *Background color* on the *Control/Settings* channel.

Control / Settings lets you configure the fixture remotely via DMX. Settings that you configure on the *Control / Settings* channel apply to both Strobe A and Strobe B.

Mode 1 RGBW Strobe

Strobe A RGBW

1	Intensity coarse
2	Intensity fine
3	Duration
4	Flash rate (Shutter)
5	Intensity effects (Strobe mode)
6	Control / Settings
7	CTC
8	Red
9	Green
10	Blue
11	White

Strobe A Background color

12	Intensity background
13	Red background
14	Green background
15	Blue background
16	White background

Strobe B RGBW

17	Intensity coarse
18	Intensity fine
19	Duration
20	Flash rate (Shutter)
21	Intensity effects (Strobe mode)
22	No function
23	CTC
24	Red
25	Green
26	Blue
27	White

Strobe B Background color

28	Intensity background
29	Red background
30	Green background
31	Blue background
32	White background

DMX Mode 2: W Strobe + RGB Strobe

68 DMX channels

White strobe with FX runs on the White segments only of Section A and Section B independently. An effects engine with 50 patterns can be operated independently on each Strobe.

RGB strobe with FX runs on the RGB segments only of Section A and Section B independently. Again, an RGB effects engine with 50 patterns can be operated independently on each Section.

Both Strobes let you control *crossfading* (duration of changes between the steps in each pattern) and *transition* (duration of changes from one pattern to the next).

Pattern chain length lets you set up a chain of fixtures for the pattern to run across – it defines the total number of fixtures in the chain. *Pattern chain position* lets you set which position in the chain the fixture will occupy: first, second or third etc. fixture in the chain. The JDC Line 1000 occupies two positions as if it was two JDC Line 500s.

Strobe phase lets you shift the timing of each RGB Strobe (A or B) by 1 – 359° relative to the corresponding White Strobe (A or B). A 180° shift will result in a flip-flop between white and RGB flashes.

Pattern phase lets you shift the timing of the RGB pattern by 1 – 359° relative to the White pattern.

Background color sets a background color on the RGB segments for Strobe A and for Strobe B. As standard, the main color output always has higher priority than the background color. You can define how background color and main color are mixed using

Mode 2 W Strobe + RGB Strobe

Strobe A White strobe with FX

1	Intensity coarse
2	Intensity fine
3	Duration
4	Flash rate (Shutter)
5	Intensity effects (Strobe mode)
6	Control / Settings
7	Pattern select
8	Pattern step / speed
9	Pattern step crossfading
10	Pattern transition
11	Pattern chain length
12	Pattern chain position

Strobe A RGB strobe with FX

13	Intensity coarse
14	Intensity fine
15	Duration
16	Flash rate (Shutter)
17	Intensity effects (Strobe mode)
18	CTC
19	Red
20	Green
21	Blue
22	Pattern select
23	Pattern step/speed
24	Pattern step crossfading
25	Pattern transition
26	Pattern chain length
27	Position in chain
28	Strobe phase
29	Pattern phase

Strobe A Background color

30	Intensity background
31	Red background
32	Green background
33	Blue background
34	White background

Strobe B White strobe with FX

35	Intensity coarse
36	Intensity fine
37	Duration
38	Flash rate (Shutter)
39	Intensity effects (Strobe mode)
40	No function
41	Pattern select
42	Pattern step / speed
43	Pattern step crossfading
44	Pattern transition
45	Pattern chain length
46	Pattern chain position

Background color on DMX channel 6, the *Control/Settings* channel. The setting selected here applies to both Strobe A and Strobe B.

Control / Settings lets you configure the fixture remotely via DMX. Settings that you configure on the *Control / Settings* channel apply to both Strobe A and Strobe B.

Strobe B RGB strobe with FX

47	Intensity coarse
48	Intensity fine
49	Duration
50	Flash rate (Shutter)
51	Intensity effects (Strobe mode)
52	CTC
53	Red
54	Green
55	Blue
56	Pattern select
57	Pattern step/speed
58	Pattern step crossfading
59	Pattern transition
60	Pattern chain length
61	Position in chain
62	Strobe phase
63	Pattern phase

Strobe B Background color

64	Intensity background
65	Red background
66	Green background
67	Blue background
68	White background

DMX Mode 3: W Strobe + RGB Pixel

168 DMX Channels

White strobe with FX runs on the White segments only of each Strobe. Each Strobe has its own effects engine with 50 patterns. *Crossfading* sets the duration of changes between the steps in each pattern. *Transition* sets the duration of changes from one pattern to the next.

Pattern chain length lets you set up a chain of fixtures for the pattern to run across in a chase by defining the total number of fixtures in the chain. *Pattern chain position* lets you set which position in the chain the fixture will occupy: first, second or third etc. fixture in the chain. The JDC Line 1000 occupies two positions as if it was two JDC Line 500s.

RGB segments overall control gives overall output control of each Strobe's individually controllable RGB segments (see below). It offers the standard strobe channels for intensity and strobe effects plus a CTC Channel which lets you adjust the color temperature of the white output.

Strobe phase lets you shift the timing of each RGB Strobe (A or B) by 1 – 359° relative to the corresponding White Strobe (A or B). A 180° shift will result in a flip-flop between white and RGB flashes.

Background color sets a background color on the RGB segments on the RGB segments for each Strobe. As standard, the main color output always has higher priority than the background color. You can define how background color and main color are mixed using *Background color* on DMX channel 6, the *Control/Settings* channel. The setting selected on the

Mode 3 W Strobe + RGB Pixel

Strobe A White strobe with FX

1	Intensity coarse
2	Intensity fine
3	Duration
4	Flash rate (Shutter)
5	Intensity effects (Strobe mode)
6	Control / Settings
7	Pattern select
8	Pattern step / speed
9	Pattern step crossfade
10	Pattern transition
11	Pattern chain length
12	Pattern chain position

Strobe A RGB segments overall control

13	Intensity coarse
14	Intensity fine
15	Duration
16	Flash rate (Shutter)
17	Intensity effects (Strobe mode)
18	CTC
19	Strobe phase

Strobe A Background color

20	Intensity background
21	Red background
22	Green background
23	Blue background
24	White background

Strobe A RGB segments individual control

25	Red segment 01
26	Green segment 01
27	Blue segment 01
...	...
82	Red segment 20
83	Green segment 20
84	Blue segment 20

Strobe B White strobe with FX

85	Intensity coarse
86	Intensity fine
87	Duration
88	Flash rate (Shutter)
89	Intensity effects (Strobe mode)
90	No function
91	Pattern select
92	Pattern step / speed
93	Pattern step crossfade
94	Pattern transition
95	Pattern chain length
96	Pattern chain position

Control / Settings channel applies to both Strobe A and Strobe B.

RGB segments individual control

adjusts the color of the individual RGB segments on each Strobe. The output of these segments is determined by the Strobe A and Strobe B *RGB segments overall control* channels (see above).

The upper and lower halves of each segment are controlled together, giving 20 RGB pixels on Strobe A and 20 RGB pixels on Strobe B.

Control / Settings lets you configure the fixture remotely via DMX. Settings that you configure on the *Control / Settings* channel apply to both Strobe A and Strobe B.

Strobe B RGB segments overall control

97	Intensity coarse
98	Intensity fine
99	Duration
100	Flash rate (Shutter)
101	Intensity effects (Strobe mode)
102	CTC
103	Strobe phase

Strobe B Background color

104	Intensity background
105	Red background
106	Green background
107	Blue background
108	White background

Strobe B RGB segments individual control

109	Red segment 01
110	Green segment 01
111	Blue segment 01
...	...
166	Red segment 20
167	Green segment 20
168	Blue segment 20



DMX Mode 4: White + RGB Strobes + W Pixel

94 DMX Channels

White segments overall control gives overall output control for each Strobe of the individually controllable White segments available for that Strobe (see below). It offers the standard strobe channels for intensity and strobe effects.

RGB strobe with FX runs on the RGB segments only of each Strobe independently. An RGB effects engine with 50 patterns can be operated on each Strobe independently.

The strobes let you control *crossfading* (duration of changes between the steps in each pattern) and *transition* (duration of changes from one pattern to the next).

Pattern chain length lets you set up a chain of fixtures for the pattern to run across – it defines the total number of fixtures in the chain. *Pattern chain position* lets you set which position in the chain the fixture will occupy: first, second or third etc. fixture in the chain. The JDC Line 1000 occupies two positions as if it was two JDC Line 500s.

Strobe phase lets you shift the timing of each RGB Strobe (A or B) by 1 – 359° relative to the corresponding White Strobe (A or B). A 180° shift will result in a flip-flop between white and RGB flashes.

Pattern phase lets you shift the timing of the RGB pattern by 1 – 359° relative to the White pattern.

Background color sets a background color on the RGB segments of each Strobe. As standard, the main color output always has higher priority than the background color. You can define how background color and main color

**Mode 4
White + RGB Strobes + W Pixel**

Strobe A White segments overall control

1	Intensity coarse
2	Intensity fine
3	Duration
4	Flash rate (Shutter)
5	Intensity effects (Strobe mode)
6	Control / Settings

Strobe A RGB strobe with FX

7	Intensity coarse
8	Intensity fine
9	Duration
10	Flash rate (Shutter)
11	Intensity effects (Strobe mode)
12	CTC
13	Red
14	Green
15	Blue
16	Pattern select
17	Pattern step / speed
18	Pattern step crossfade
19	Pattern transition
20	Pattern chain length
21	Position in chain
22	Strobe phase

Strobe A Background color

23	Intensity background
24	Red background
25	Green background
26	Blue background
27	White background

Strobe A White segments individual control

28	White segment 01
...	...
47	White segment 20



are mixed using *Background color* on DMX channel 6, the *Control/Settings* channel. The setting selected on the *Control / Settings* channel applies to both Strobe A and Strobe B.

White segments individual control

adjusts the output of the individual White segments on each Strobe. The overall output of these segments is determined by the *White segments overall control* channels (see above) for each Strobe.

Control / Settings lets you configure the fixture remotely via DMX. Settings that you configure on the *Control / Settings* channel apply to both Strobe A and Strobe B.

Strobe B White segments overall control

48	Intensity coarse
49	Intensity fine
50	Duration
51	Flash rate (Shutter)
52	Intensity effects (Strobe mode)
53	No function

Strobe B RGB strobe with FX

54	Intensity coarse
55	Intensity fine
56	Duration
57	Flash rate (Shutter)
58	Intensity effects (Strobe mode)
59	CTC
60	Red
61	Green
62	Blue
63	Pattern select
64	Pattern step / speed
65	Pattern step crossfade
66	Pattern transition
67	Pattern chain length
68	Position in chain
69	Strobe phase

Strobe B Background color

70	Intensity background
71	Red background
72	Green background
73	Blue background
74	White background

Strobe B White segments individual control

75	White segment 01
...	...
94	White segment 20



DMX Mode 5: Multipix

196 DMX Channels

White segments overall control gives overall output control for each Strobe's individually controllable White segments (see below). It offers the standard strobe channels for intensity and strobe effects.

RGB segments overall control gives an overall output control of each Strobe's individually controllable RGB segments (see below). It offers the standard strobe channels for intensity and strobe effects plus a CTC Channel which lets you adjust the color temperature of the white output.

Strobe phase lets you shift the timing of each RGB Strobe (A or B) by 1 – 359° relative to the corresponding White Strobe (A or B). A 180° shift will result in a flip-flop between white and RGB flashes.

Background color sets a background color on each Strobe's RGB segments. As standard, the main color output always has higher priority than the background color. You can define how background color and main color are mixed using *Background color* on DMX channel 6, the *Control/Settings* channel. The setting selected on the *Control / Settings* channel applies to both Strobe A and Strobe B.

White segments individual control adjusts the output of each Strobe's individual White segments. The overall output of these segments is determined by the *White segments overall control* channels (see above) for each Strobe.

RGB segments individual control adjusts the color of each Strobe's individual RGB segments. The output of these segments is determined by the

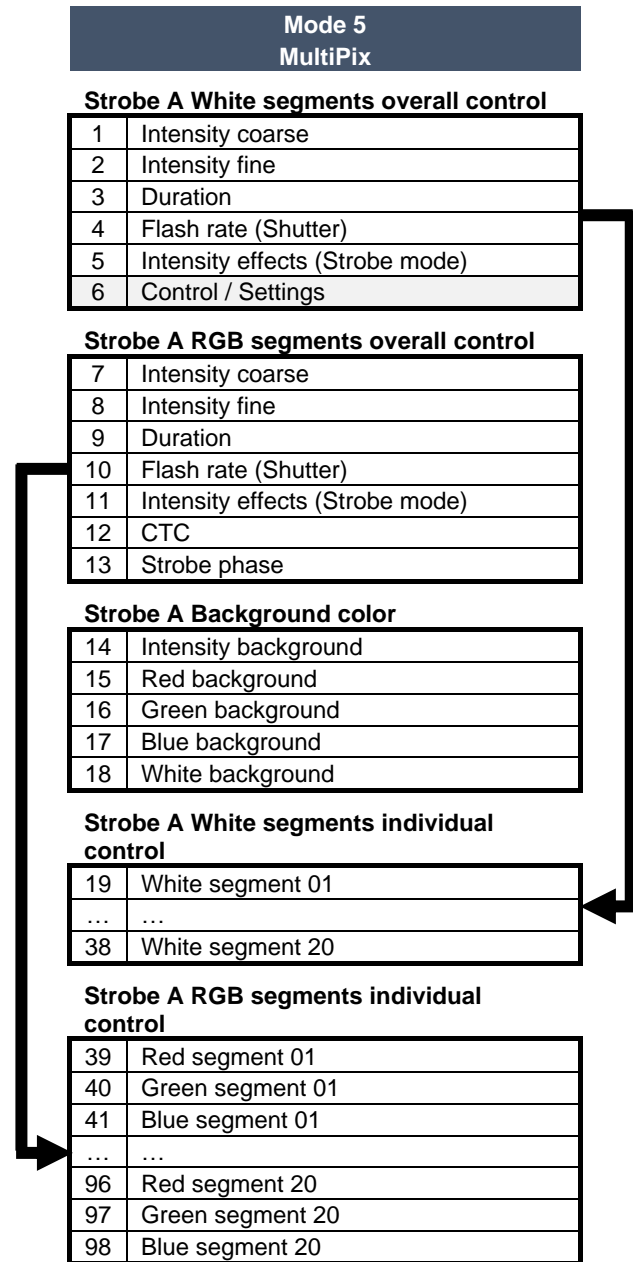

RGB segments overall control channels (see above) for each strobe.

The upper and lower halves of each RGB segment are controlled together, giving individual RGB control of 20 RGB pixels for Strobe A and 20 RGB pixels for Strobe B.

Control / Settings lets you configure the fixture remotely via DMX. Settings that you configure on the *Control / Settings* channel apply to both Strobe A and Strobe B.

Strobe B White segments overall control

99	Intensity coarse
100	Intensity fine
101	Duration
102	Flash rate (Shutter)
103	Intensity effects (Strobe mode)
104	Control / Settings

Strobe B RGB segments overall control

105	Intensity coarse
106	Intensity fine
107	Duration
108	Flash rate (Shutter)
109	Intensity effects (Strobe mode)
110	CTC
111	Strobe phase

Strobe B Background color

112	Intensity background
113	Red background
114	Green background
115	Blue background
116	White background

Strobe B White segments individual control

117	White segment 01
...	...
136	White segment 20

Strobe B RGB segments individual control

137	Red segment 01
138	Green segment 01
139	Blue segment 01
...	...
194	Red segment 20
195	Green segment 20
196	Blue segment 20

DMX Mode 6: MultiPix Advanced

316 DMX Channels

White segments overall control gives overall output control of each Strobe's individually controllable White segments (see below). It offers the standard strobe channels for intensity and strobe effects.

RGB segments overall control gives an overall output control of each Strobe's individually controllable RGB segments (see below). It offers the standard strobe channels for intensity and strobe effects plus a CTC Channel which lets you adjust the color temperature of the white output.

Strobe phase lets you shift the timing of each RGB Strobe (A or B) by 1 – 359° relative to the corresponding White Strobe (A or B). A 180° shift will result in a flip-flop between white and RGB flashes.

Background color sets a background color on each Strobe's RGB segments. As standard, the main color output always has higher priority than the background color. You can define how background color and main color are mixed using *Background color* on DMX channel 6, the *Control/Settings* channel. The setting selected on the *Control / Settings* channel applies to both Strobe A and Strobe B.

White segments individual control adjusts the output of each Strobe's individual White segments. The overall output of these segments is determined by each Strobe's *White segments overall control* channels (see above).

RGB segments individual control (upper, lower) adjusts the color of each Strobe's individual RGB segments. The output of these segments is determined by each

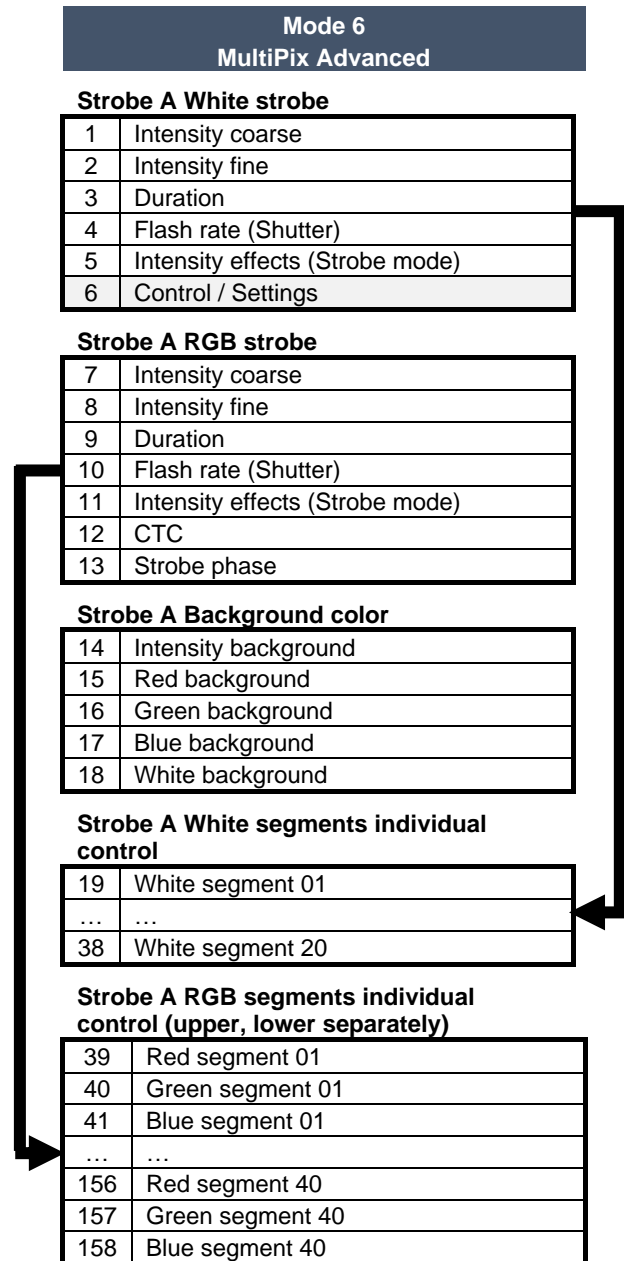

Strobe's RGB segments overall control channels (see above).

The RGB segments on each Strobe are split into upper and lower halves with individual control of each half. This gives individual RGB control of 40 RGB pixels on Strobe A and 40 RGB pixels on Strobe B.

Control / Settings lets you configure the fixture remotely via DMX. Settings that you configure on the *Control / Settings* channel apply to both Strobe A and Strobe B.

Strobe B White strobe

159	Intensity coarse
160	Intensity fine
161	Duration
162	Flash rate (Shutter)
163	Intensity effects (Strobe mode)
164	No function

Strobe B RGB strobe

165	Intensity coarse
166	Intensity fine
167	Duration
168	Flash rate (Shutter)
169	Intensity effects (Strobe mode)
170	CTC
171	Strobe phase

Strobe B Background color

172	Intensity background
173	Red background
174	Green background
175	Blue background
176	White background

Strobe B White segments individual control

177	White segment 01
...	...
196	White segment 20

Strobe B RGB segments individual control (upper, lower separately)

197	Red segment 01
198	Green segment 01
199	Blue segment 01
...	...
314	Red segment 40
315	Green segment 40
316	Blue segment 40

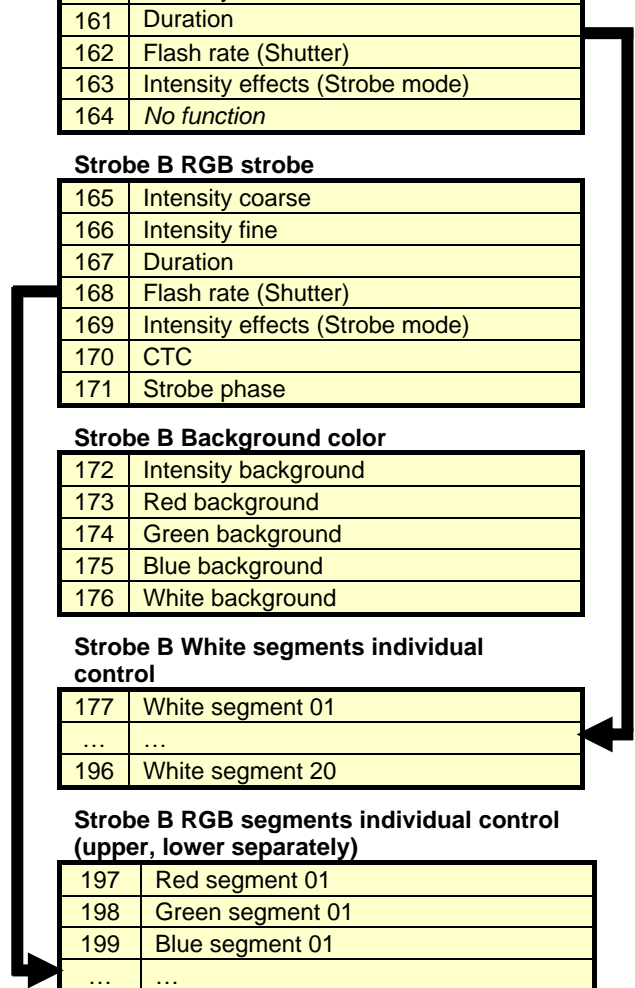

DMX Mode 7: MultiPix Quadpix

76 DMX Channels

White segments overall control gives overall output control of each Strobe's individually controllable White segments (see below). It offers the standard strobe channels for intensity and strobe effects.

RGB segments overall control gives an overall output control of each Strobe's individually controllable RGB segments (see below). It offers the standard strobe channels for intensity and strobe effects plus a CTC Channel which lets you adjust the color temperature of the white output.

Strobe phase lets you shift the timing of each RGB Strobe (A or B) by 1 – 359° relative to the corresponding White Strobe (A or B). A 180° shift will result in a flip-flop between white and RGB flashes.

Background color sets a background color on each Strobe's RGB segments. As standard, the main color output always has higher priority than the background color. You can define how background color and main color are mixed using *Background color* on DMX channel 6, the *Control/Settings* channel. The setting selected on the *Control / Settings* channel applies to both Strobe A and Strobe B.

White quad segments divides each Strobe's 20 White segments into 5 quad segments, each containing 4 segments, and gives intensity control. The overall output of these quad segments is determined by each Strobe's *White segments overall control* channels (see above).

RGB quad segments divides each Strobe's 20 RGB segments into 5 quad segments, each containing 4 segments, and gives RGB control. The

Mode 7 MultiPix Quadpix

Strobe A White strobe

1	Intensity coarse
2	Intensity fine
3	Duration
4	Flash rate (Shutter)
5	Intensity effects (Strobe mode)
6	Control / Settings

Strobe A RGB strobe

7	Intensity coarse
8	Intensity fine
9	Duration
10	Flash rate (Shutter)
11	Intensity effects (Strobe mode)
12	CTC
13	Strobe phase

Strobe A Background color

14	Intensity background
15	Red background
16	Green background
17	Blue background
18	White background

Strobe A White quad segments

19	White quad segment 1
...	...
23	White quad segment 5

Strobe A RGB quad segments

24	Red quad segment 1
25	Green quad segment 1
26	Blue quad segment 1
...	...
36	Red quad segment 5
37	Green quad segment 5
38	Blue quad segment 5

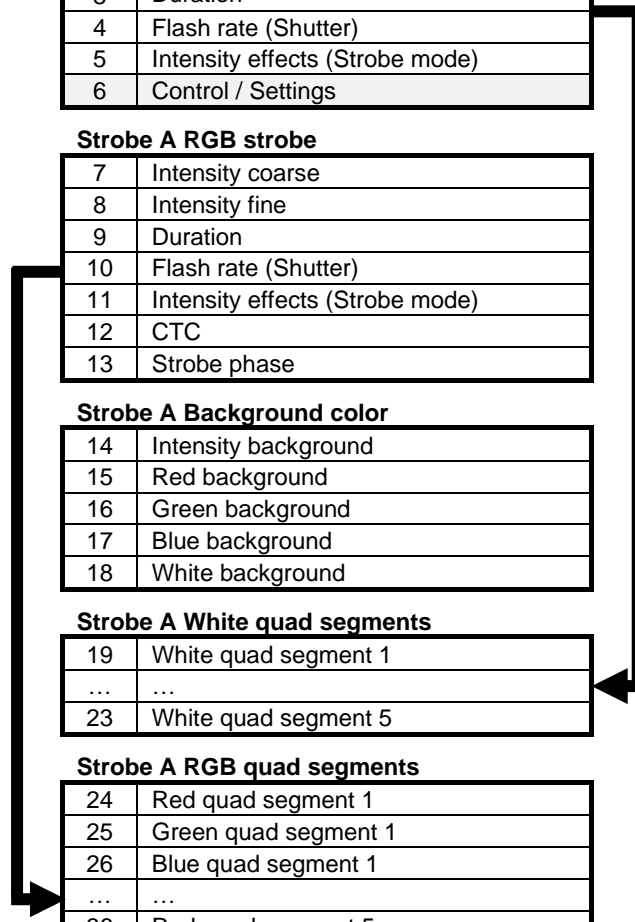

overall output of these quad segments is determined by each Strobe's RGB segments overall control channels (see above).

Control / Settings lets you configure the fixture remotely via DMX. Settings that you configure on the *Control / Settings* channel apply to both Strobe A and Strobe B.

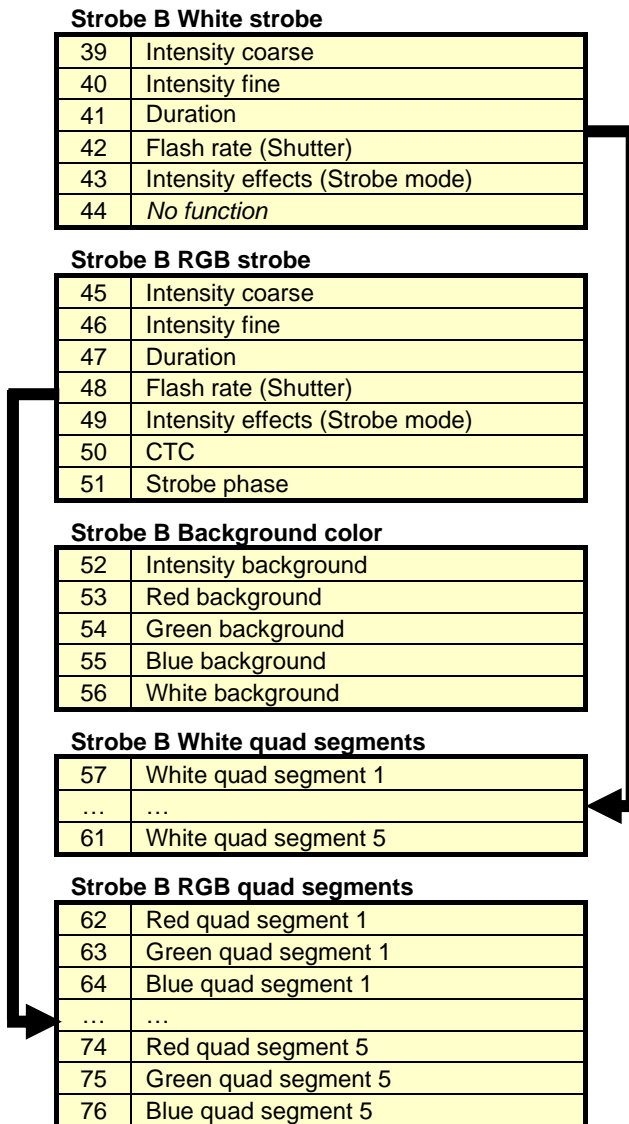

8. DMX control channel layout

In the following DMX channel layout tables:

- Default settings are indicated with **bold type**.
- Where commands are followed by (3s hold) you must send that value continuously for 3 seconds (or other duration if indicated in the table) to apply the command.
- Some commands on the Control / Settings channel require the DMX value zero to be sent first and then moved directly to the DMX value required by the command concerned.
- Adjustments made on the Control / Settings channel apply to both Strobe A and Strobe B.



DMX Mode 1: RGBW Strobe

32 DMX Channels

Channel	Command	DMX range	Percent %	Default DMX	Fade
---------	---------	-----------	-----------	-------------	------

STROBE A Global RGBW strobe

1	Global intensity coarse	RGBW intensity 0 → 100% (16-bit)	0	65535	0	100	0	Fade
	2							
3	Global flash duration	Flash duration short → long	0	255	0	100	0	Fade
4	Global flash rate (Shutter)	Closed	0	4	0	1.6	0	Snap
		Flash rate slow → fast	5	250	2	97.6		Fade
		Open	251	255	98	100		Snap
5	Global intensity effects (Strobe mode)	Off: normal sync flashes	0	14	0	5.5	0	Snap
		Single flash if change on flash rate channel	15	29	5.9	11.4		
		Pulse	30	44	11.8	17.3		
		Pulse opening	45	59	17.6	23.1		
		Pulse closing	60	74	23.5	29.0		
		Pulse random	75	89	29.4	34.9		
		Pulse opening random	90	104	35.3	40.8		
		Pulse closing random	105	119	41.2	46.7		
		Double flash	120	134	47.1	52.5		
		Double flash random	135	149	52.9	58.4		
		Triple flash	150	164	58.8	64.3		
		Triple flash random	165	179	64.7	70.2		
		Spikes	180	194	70.6	76.1		
		Lightning	195	209	76.5	82.0		
Random pixel flash	210	224	82.4	87.8				
Random fixture flash	225	239	88.2	93.7				
Flash offset between fixtures (adjust offset on Global flash rate channel)	240	255	94.1	100				
6	Control /Settings	See 'Control / Settings channel' on page 65						
7	CTC (RGB)	Open	0	10	0	3,9	0	Snap
		10 000 K	11	11	4.3	4.3		Fade
		...	12	254	4.7	99.2		
		2 500 K	255	255	100	100		
8	Red intensity	Intensity 0 → 100%	0	255	0	100	0	Fade
9	Green intensity	Intensity 0 → 100%	0	255	0	100	0	Fade
10	Blue intensity	Intensity 0 → 100%	0	255	0	100	0	Fade
11	White intensity	Intensity 0 → 100%	0	255	0	100	0	Fade

STROBE A Background color

12	Intensity backgnd.	Intensity 0 → 100%	0	255	0	100	0	Fade
13	Red background	Intensity 0 → 100%	0	255	0	100	0	Fade
14	Green background	Intensity 0 → 100%	0	255	0	100	0	Fade
15	Blue background	Intensity 0 → 100%	0	255	0	100	0	Fade
16	White background	Intensity 0 → 100%	0	255	0	100	0	Fade

STROBE B Global RGBW strobe

17	Global intensity coarse	RGBW intensity 0 → 100% (16-bit)	0	65535	0	100	0	Fade
18	Global intensity fine							
19	Global flash duration	Flash duration short → long	0	255	0	100	0	Fade
20	Global flash rate (Shutter)	Closed	0	4	0	1.6	0	Snap
		Flash rate slow → fast	5	250	2	97.6		Fade
		Open	251	255	98	100		Snap
21	Global intensity effects (Strobe mode)	Off: normal sync flashes	0	14	0	5.5	0	Snap
		Single flash if change on flash rate channel	15	29	5.9	11.4		
		Pulse	30	44	11.8	17.3		
		Pulse opening	45	59	17.6	23.1		
		Pulse closing	60	74	23.5	29.0		
		Pulse random	75	89	29.4	34.9		
		Pulse opening random	90	104	35.3	40.8		
		Pulse closing random	105	119	41.2	46.7		
		Double flash	120	134	47.1	52.5		
		Double flash random	135	149	52.9	58.4		
		Triple flash	150	164	58.8	64.3		
		Triple flash random	165	179	64.7	70.2		
		Spikes	180	194	70.6	76.1		
		Lightning	195	209	76.5	82.0		
Random pixel flash	210	224	82.4	87.8				
Random fixture flash	225	239	88.2	93.7				
Flash offset between fixtures (adjust offset on Global flash rate channel)	240	255	94.1	100				
22	No function							
23	CTC (RGB)	Open	0	10	0	3,9	0	Snap
		10 000 K	11	11	4.3	4.3		Fade
		...	12	254	4.7	99.2		
		2 500 K	255	255	100	100		
24	Red intensity	Intensity 0 → 100%	0	255	0	100	0	Fade
25	Green intensity	Intensity 0 → 100%	0	255	0	100	0	Fade
26	Blue intensity	Intensity 0 → 100%	0	255	0	100	0	Fade
27	White intensity	Intensity 0 → 100%	0	255	0	100	0	Fade

STROBE B Background color

28	Intensity backgnd.	Intensity 0 → 100%	0	255	0	100	0	Fade
29	Red background	Intensity 0 → 100%	0	255	0	100	0	Fade
30	Green background	Intensity 0 → 100%	0	255	0	100	0	Fade
31	Blue background	Intensity 0 → 100%	0	255	0	100	0	Fade
32	White background	Intensity 0 → 100%	0	255	0	100	0	Fade



DMX Mode 2: W Strobe + RGB Strobe

68 DMX Channels

Channel	Command	DMX range	Percent %	Default DMX	Fade			
STROBE A White strobe with FX								
1	White intensity coarse	White intensity 0 → 100% (16-bit)	0	65535	0	100	0	Fade
2	White intensity fine							
3	White flash duration	Flash duration short → long	0	255	0	100	0	Fade
4	White flash rate (Shutter)	Closed	0	4	0	1.6	0	Snap
		Flash rate slow → fast	5	250	2	97.6		Fade
		Open	251	255	98	100		Snap
5	White intensity effects (Strobe mode)	Off: normal sync flashes	0	14	0	5.5	0	Snap
		Single flash if change on flash rate channel	15	29	5.9	11.4		
		Pulse	30	44	11.8	17.3		
		Pulse opening	45	59	17.6	23.1		
		Pulse closing	60	74	23.5	29.0		
		Pulse random	75	89	29.4	34.9		
		Pulse opening random	90	104	35.3	40.8		
		Pulse closing random	105	119	41.2	46.7		
		Double flash	120	134	47.1	52.5		
		Double flash random	135	149	52.9	58.4		
		Triple flash	150	164	58.8	64.3		
		Triple flash random	165	179	64.7	70.2		
		Spikes	180	194	70.6	76.1		
		Lightning	195	209	76.5	82.0		
		Random pixel flash	210	224	82.4	87.8		
Random fixture flash	225	239	88.2	93.7				
Flash offset between fixtures (adjust offset on Global flash rate channel)	240	247	94.1	96.9				
Random pattern	248	251	97.3	98.4				
Random pixel	252	255	98.8	100				
6	Control /Settings	See 'Control / Settings channel' on page 65						
7	White FX pattern select	Off (White patterns inactive)	0	11	0	4.3	0	Snap
		Pattern 01	12	15	4.7	5.9		
		Patterns 02 ... 49		
		Pattern 50	208	211	81.6	82.8		
		No function	212	247	83.1	100		
8	White pattern step select / speed	Pattern step 01	0	2	0	0.8	0	Snap
		Pattern steps 02 ... 39		Snap
		Pattern step 40	117	119	45.9	46.7		Snap
		No function	120	127	47.1	49.8		Snap
		CW fast → slow (run pattern step 1 ... n)	128	190	50.2	74.5		Fade
		Stop	191	192	74.9	75.3		Snap
		CCW slow → fast (run pattern step n ... 1)	193	255	75.7	100		Fade

9	White pattern step crossfading	No crossfading, snap from one step to next	0	5	0	3.9	0	Snap
		Snap → longest crossfade (fade in and fade out times are identical)	6	127	4.3	49.0		Fade
		No crossfading, snap from one step to next	128	133	49.4	51.0		Snap
		Snap → longest crossfade with tail (fade-in time is shorter than fade out time, creates a shadow effect)	134	255	51.4	100		Fade
10	White pattern transition	No transition time, snap from one pattern to next	0	10	0	3.9	0	Snap
		Snap → 15 sec. transition time	11	68	4.3	26.7		Fade
		No transition time, snap from one pattern to next	69	73	27.1	28.6		Snap
		FOB (Fade Over Blackout) transition, Snap → 15 sec. transition time	74	130	29.0	51.0		Fade
		No transition time, snap from one pattern to next	131	135	51.4	52.9		Snap
		FOF (Fade Over Full) transition, Snap → 15 sec. transition time	136	193	53.3	75.7		Fade
		No function	194	255	76.1	100		
11	White pattern chain length	Off (no chain)	0	0	0	0	0	Snap
		Total length of pattern chain: 1 → 255 fixtures	1	255	0.4	100		Fade
12	White pattern position in chain	Off (no chain)	0	0	0	0	0	Snap
		Fixture is number 1 → number 255 in the chain	1	255	0.4	100		Fade

STROBE A RGB strobe with FX

13	RGB intensity coarse	RGB intensity 0 → 100% (16-bit)	0	65535	0	100	0	Fade
14	RGB intensity fine							
15	RGB duration	Flash duration short → long	0	255	0	100	0	Fade
16	RGB flash rate (Shutter)	Closed	0	4	0	1.6	0	Snap
		Flash rate slow → fast	5	250	2	97.6		Fade
		Open	251	255	98	100		Snap
17	RGB intensity effects (Strobe mode)	Off: normal sync flashes	0	14	0	5.5	0	Snap
		Single flash if change on flash rate channel	15	29	5.9	11.4		
		Pulse	30	44	11.8	17.3		
		Pulse opening	45	59	17.6	23.1		
		Pulse closing	60	74	23.5	29.0		
		Pulse random	75	89	29.4	34.9		
		Pulse opening random	90	104	35.3	40.8		
		Pulse closing random	105	119	41.2	46.7		
		Double flash	120	134	47.1	52.5		
		Double flash random	135	149	52.9	58.4		
		Triple flash	150	164	58.8	64.3		
		Triple flash random	165	179	64.7	70.2		
		Spikes	180	194	70.6	76.1		
		Lightning	195	209	76.5	82.0		
		Random pixel flash	210	224	82.4	87.8		
Random fixture flash	225	239	88.2	93.7				
	Flash offset between fixtures (adjust offset on Global flash rate channel)	240	255	94.1	100			

18	CTC (RGB)	Open	0	10	0	3.9	0	Snap
		10 000 K	11	11	4.3	4.3		Fade
		...	12	254	4.7	99.2		
		2 500 K	255	255	100	100		
19	Red	Intensity 0 → 100%	0	255	0	100	0	Fade
20	Green	Intensity 0 → 100%	0	255	0	100	0	Fade
21	Blue	Intensity 0 → 100%	0	255	0	100	0	Fade
22	RGB FX pattern select	Off (all white patterns inactive)	0	11	0	4.3	0	Snap
		Pattern 01	12	15	4.7	5.9		
		Patterns 02 ... 49		
		Pattern 50	208	211	81.6	82.8		
		No function	212	247	83.1	100		
23	RGB pattern step select / speed	Pattern step 01	0	2	0	0.8	0	Snap
		Pattern steps 02 ... 39		Snap
		Pattern step 40	117	119	45.9	46.7		Snap
		No function	120	127	47.1	49.8		Snap
		CW fast → slow (run pattern step 1 ... n)	128	190	50.2	74.5		Fade
		Stop	191	192	74.9	75.3		Snap
		CCW slow → fast (run pattern step n ... 1)	193	255	75.7	100		Fade
24	RGB pattern step crossfading	No crossfading, snap from one step to next	0	5	0	3.9	0	Snap
		Snap → longest crossfade (fade in and fade out times are identical)	6	127	4.3	49.0		Fade
		No crossfading, snap from one step to next	128	133	49.4	51.0		Snap
		Snap → longest crossfade with tail (fade-in time is shorter than fade out time, creates a shadow effect)	134	255	51.4	100		Fade
25	RGB pattern transition	No transition time, snap from one pattern to next	0	10	0	3.9	0	Snap
		Snap → 15 sec. transition time	11	68	4.3	26.7		Fade
		No transition time, snap from one pattern to next	69	73	27.1	28.6		Snap
		FOB (Fade Over Blackout) transition, Snap → 15 sec. transition time	74	130	29.0	51.0		Fade
		No transition time, snap from one pattern to next	131	135	51.4	52.9		Snap
		FOF (Fade Over Full) transition, Snap → 15 sec. transition time	136	193	53.3	75.7		Fade
		No function	194	255	76.1	100		
26	RGB pattern chain length	Off (pattern length: normal)	0	0	0	0	0	Snap
		Pattern length: 1 → 255 steps	1	255	0.4	100		Fade
27	RGB pattern position in chain	Off (pattern starts at Step 1)	0	0	0	0	0	Snap
		Pattern starts at Step 1 → Step 255	1	255	0.4	100		Fade
28	RGB strobe phase	RGB strobe timing shift 0° → 359° relative to White strobe	0	255	0	100	0	Fade
29	RGB pattern phase	RGB pattern timing shift 0° → 359° relative to White strobe	0	255	0	100	0	Fade

STROBE A Background color

30	Intensity backgd.	Intensity 0 → 100%	0	255	0	100	0	Fade
31	Red background	Intensity 0 → 100%	0	255	0	100	0	Fade
32	Green background	Intensity 0 → 100%	0	255	0	100	0	Fade
33	Blue background	Intensity 0 → 100%	0	255	0	100	0	Fade
34	White background	Intensity 0 → 100%	0	255	0	100	0	Fade

STROBE B White strobe with FX

35	White intensity coarse	White intensity 0 → 100% (16-bit)	0	65535	0	100	0	Fade
36	White intensity fine							
37	White flash duration	Flash duration short → long	0	255	0	100	0	Fade
38	White flash rate (Shutter)	Closed	0	4	0	1.6	0	Snap
		Flash rate slow → fast	5	250	2	97.6		Fade
		Open	251	255	98	100		Snap
39	White intensity effects (Strobe mode)	Off: normal sync flashes	0	14	0	5.5	0	Snap
		Single flash if change on flash rate channel	15	29	5.9	11.4		
		Pulse	30	44	11.8	17.3		
		Pulse opening	45	59	17.6	23.1		
		Pulse closing	60	74	23.5	29.0		
		Pulse random	75	89	29.4	34.9		
		Pulse opening random	90	104	35.3	40.8		
		Pulse closing random	105	119	41.2	46.7		
		Double flash	120	134	47.1	52.5		
		Double flash random	135	149	52.9	58.4		
		Triple flash	150	164	58.8	64.3		
		Triple flash random	165	179	64.7	70.2		
		Spikes	180	194	70.6	76.1		
		Lightning	195	209	76.5	82.0		
		Random pixel flash	210	224	82.4	87.8		
		Random fixture flash	225	239	88.2	93.7		
	Flash offset between fixtures (adjust offset on Global flash rate channel)	240	247	94.1	96.9			
	Random pattern	248	251	97.3	98.4			
	Random pixel	252	255	98.8	100			
40	<i>No function</i>							
41	White FX pattern select	Off (White patterns inactive)	0	11	0	4.3	0	Snap
		Pattern 01	12	15	4.7	5.9		
		Patterns 02 ... 49		
		Pattern 50	208	211	81.6	82.8		
		<i>No function</i>	212	247	83.1	100		
42	White pattern step select / speed	Pattern step 01	0	2	0	0.8	0	Snap
		Pattern steps 02 ... 39		Snap
		Pattern step 40	117	119	45.9	46.7		Snap
		<i>No function</i>	120	127	47.1	49.8		Snap
		CW fast → slow (run pattern step 1 ... n)	128	190	50.2	74.5		Fade
		Stop	191	192	74.9	75.3		Snap
		CCW slow → fast (run pattern step n ... 1)	193	255	75.7	100		Fade



43	White pattern step crossfading	No crossfading, snap from one step to next	0	5	0	3.9	0	Snap
		Snap → longest crossfade (fade in and fade out times are identical)	6	127	4.3	49.0		Fade
		No crossfading, snap from one step to next	128	133	49.4	51.0		Snap
		Snap → longest crossfade with tail (fade-in time is shorter than fade out time, creates a shadow effect)	134	255	51.4	100		Fade
44	White pattern transition	No transition time, snap from one pattern to next	0	10	0	3.9	0	Snap
		Snap → 15 sec. transition time	11	68	4.3	26.7		Fade
		No transition time, snap from one pattern to next	69	73	27.1	28.6		Snap
		FOB (Fade Over Blackout) transition, Snap → 15 sec. transition time	74	130	29.0	51.0		Fade
		No transition time, snap from one pattern to next	131	135	51.4	52.9		Snap
		FOF (Fade Over Full) transition, Snap → 15 sec. transition time	136	193	53.3	75.7		Fade
		No function	194	255	76.1	100		
45	White pattern chain length	Off (no chain)	0	0	0	0	0	Snap
		Total length of pattern chain: 1 → 255 fixtures	1	255	0.4	100		Fade
46	White pattern position in chain	Off (no chain)	0	0	0	0	0	Snap
		Fixture is number 1 → number 255 in the chain	1	255	0.4	100		Fade

STROBE B RGB strobe with FX

47	RGB intensity coarse	RGB intensity 0 → 100% (16-bit)	0	65535	0	100	0	Fade
48	RGB intensity fine							
49	RGB duration	Flash duration short → long	0	255	0	100	0	Fade
50	RGB flash rate (Shutter)	Closed	0	4	0	1.6	0	Snap
		Flash rate slow → fast	5	250	2	97.6		Fade
		Open	251	255	98	100		Snap
51	RGB intensity effects (Strobe mode)	Off: normal sync flashes	0	14	0	5.5	0	Snap
		Single flash if change on flash rate channel	15	29	5.9	11.4		
		Pulse	30	44	11.8	17.3		
		Pulse opening	45	59	17.6	23.1		
		Pulse closing	60	74	23.5	29.0		
		Pulse random	75	89	29.4	34.9		
		Pulse opening random	90	104	35.3	40.8		
		Pulse closing random	105	119	41.2	46.7		
		Double flash	120	134	47.1	52.5		
		Double flash random	135	149	52.9	58.4		
		Triple flash	150	164	58.8	64.3		
		Triple flash random	165	179	64.7	70.2		
		Spikes	180	194	70.6	76.1		
		Lightning	195	209	76.5	82.0		
		Random pixel flash	210	224	82.4	87.8		
Random fixture flash	225	239	88.2	93.7				
	Flash offset between fixtures (adjust offset on Global flash rate channel)	240	255	94.1	100			

52	CTC (RGB)	Open	0	10	0	3.9	0	Snap
		10 000 K	11	11	4.3	4.3		Fade
		...	12	254	4.7	99.2		
		2 500 K	255	255	100	100		
53	Red	Intensity 0 → 100%	0	255	0	100	0	Fade
54	Green	Intensity 0 → 100%	0	255	0	100	0	Fade
55	Blue	Intensity 0 → 100%	0	255	0	100	0	Fade
56	RGB FX pattern select	Off (all white patterns inactive)	0	11	0	4.3	0	Snap
		Pattern 01	12	15	4.7	5.9		
		Patterns 02 ... 49		
		Pattern 50	208	211	81.6	82.8		
		No function	212	247	83.1	100		
57	RGB pattern step select / speed	Pattern step 01	0	2	0	0.8	0	Snap
		Pattern steps 02 ... 39		Snap
		Pattern step 40	117	119	45.9	46.7		Snap
		No function	120	127	47.1	49.8		Snap
		CW fast → slow (run pattern step 1 ... n)	128	190	50.2	74.5		Fade
		Stop	191	192	74.9	75.3		Snap
		CCW slow → fast (run pattern step n ... 1)	193	255	75.7	100		Fade
58	RGB pattern step crossfading	No crossfading, snap from one step to next	0	5	0	3.9	0	Snap
		Snap → longest crossfade (fade in and fade out times are identical)	6	127	4.3	49.0		Fade
		No crossfading, snap from one step to next	128	133	49.4	51.0		Snap
		Snap → longest crossfade with tail (fade-in time is shorter than fade out time, creates a shadow effect)	134	255	51.4	100		Fade
59	RGB pattern transition	No transition time, snap from one pattern to next	0	10	0	3.9	0	Snap
		Snap → 15 sec. transition time	11	68	4.3	26.7		Fade
		No transition time, snap from one pattern to next	69	73	27.1	28.6		Snap
		FOB (Fade Over Blackout) transition, Snap → 15 sec. transition time	74	130	29.0	51.0		Fade
		No transition time, snap from one pattern to next	131	135	51.4	52.9		Snap
		FOF (Fade Over Full) transition, Snap → 15 sec. transition time	136	193	53.3	75.7		Fade
		No function	194	255	76.1	100		
60	RGB pattern chain length	Off (pattern length: normal)	0	0	0	0	0	Snap
		Pattern length: 1 → 255 steps	1	255	0.4	100		Fade
61	RGB pattern position in chain	Off (pattern starts at Step 1)	0	0	0	0	0	Snap
		Pattern starts at Step 1 → Step 255	1	255	0.4	100		Fade
62	RGB strobe phase	RGB strobe timing shift 0° → 359° relative to White strobe	0	255	0	100	0	Fade
63	RGB pattern phase	RGB pattern timing shift 0° → 359° relative to White strobe	0	255	0	100	0	Fade

STROBE B Background color

64	Intensity backgnd.	Intensity 0 → 100%	0	255	0	100	0	Fade
65	Red background	Intensity 0 → 100%	0	255	0	100	0	Fade
66	Green background	Intensity 0 → 100%	0	255	0	100	0	Fade
67	Blue background	Intensity 0 → 100%	0	255	0	100	0	Fade
68	White background	Intensity 0 → 100%	0	255	0	100	0	Fade



DMX Mode 3: W Strobe + RGB Pixel

168 DMX Channels

Channel	Command	DMX range	Percent %	Default DMX	Fade			
STROBE A White strobe with FX patterns								
1	White intensity coarse	White intensity 0 → 100% (16-bit)	0	65535	0	100	0	Fade
2	White intensity fine							
3	White flash duration	Flash duration short → long	0	255	0	100	0	Fade
4	White flash rate (Shutter)	Closed	0	4	0	1.6	0	Snap
		Flash rate slow → fast	5	250	2	97.6		Fade
		Open	251	255	98	100		Snap
5	White intensity effects (Strobe mode)	Off (normal sync flashes)	0	14	0	5.5	0	Snap
		Single flash if change on flash rate channel	15	29	5.9	11.4		
		Pulse	30	44	11.8	17.3		
		Pulse opening	45	59	17.6	23.1		
		Pulse closing	60	74	23.5	29.0		
		Pulse random	75	89	29.4	34.9		
		Pulse opening random	90	104	35.3	40.8		
		Pulse closing random	105	119	41.2	46.7		
		Double flash	120	134	47.1	52.5		
		Double flash random	135	149	52.9	58.4		
		Triple flash	150	164	58.8	64.3		
		Triple flash random	165	179	64.7	70.2		
		Spikes	180	194	70.6	76.1		
		Lightning	195	209	76.5	82.0		
		Random pixel flash	210	224	82.4	87.8		
Random fixture flash	225	239	88.2	93.7				
Flash offset between fixtures (adjust offset on Global flash rate channel)	240	247	94.1	96.9				
Random pattern	248	251	97.3	98.4				
Random pixel	252	255	98.8	100				
6	Control /Settings	See 'Control / Settings channel' on page 65						
7	White FX pattern select	Off (all white patterns inactive)	0	11	0	4.3	0	Snap
		Pattern 01	12	15	4.7	5.9		
		Patterns 02 ... 49		
		Pattern 50	208	211	81.6	82.8		
		No function	212	247	83.1	100		
8	White pattern step select / speed	Pattern step 01	0	2	0	0.8	0	Snap
		Pattern steps 02 ... 39		Snap
		Pattern step 40	117	119	45.9	46.7		Snap
		No function	120	127	47.1	49.8		Snap
		CW fast → slow (run pattern step 1 ... n)	128	190	50.2	74.5		Fade
		Stop	191	192	74.9	75.3		Snap
		CCW slow → fast (run pattern step n ... 1)	193	255	75.7	100		Fade

9	White pattern step crossfading	No crossfading, snap from one step to next	0	5	0	3.9	0	Snap
		Snap ... longest crossfade (fade in and fade out times are identical)	6	127	4.3	49.0		Fade
		No crossfading, snap from one step to next	128	133	49.4	51.0		Snap
		Snap → longest crossfade with tail (fade-in time is shorter than fade out time, creates a shadow effect)	134	255	51.4	100		Fade
10	White pattern transition	No transition time, snap from one pattern to next	0	10	0	3.9	0	Snap
		Snap → 15 sec. transition time	11	68	4.3	26.7		Fade
		No transition time, snap from one pattern to next	69	73	27.1	28.6		Snap
		FOB (Fade Over Blackout) transition, Snap → 15 sec. transition time	74	130	29.0	51.0		Fade
		No transition time, snap from one pattern to next	131	135	51.4	52.9		Snap
		FOF (Fade Over Full) transition, Snap → 15 sec. transition time	136	193	53.3	75.7		Fade
		No function	194	255	76.1	100		
11	White pattern chain length	Off (no chain)	0	0	0	0	0	Snap
		Total length of pattern chain: 1 → 255 fixtures	1	255	0.4	100		Fade
12	White pattern position in chain	Off (no chain)	0	0	0	0	0	Snap
		Fixture is number 1 → number 255 in the chain	1	255	0.4	100		Fade

STROBE A RGB segments overall control

13	RGB intensity coarse	Intensity 0 → 100% (16-bit)	0	65535	0	100	0	Fade
14	RGB intensity fine							
15	RGB duration	Flash duration short → long	0	255	0	100	0	Fade
16	RGB flash rate (Shutter)	Closed	0	4	0	1.6	0	Snap
		Flash rate slow → fast	5	250	2	97.6		Fade
		Open	251	255	98	100		Snap
17	RGB strobe intensity effects (Strobe mode)	Off (normal sync flashes)	0	14	0	5.5	0	Snap
		Single flash if change on flash rate channel	15	29	5.9	11.4		
		Pulse	30	44	11.8	17.3		
		Pulse opening	45	59	17.6	23.1		
		Pulse closing	60	74	23.5	29.0		
		Pulse random	75	89	29.4	34.9		
		Pulse opening random	90	104	35.3	40.8		
		Pulse closing random	105	119	41.2	46.7		
		Double flash	120	134	47.1	52.5		
		Double flash random	135	149	52.9	58.4		
		Triple flash	150	164	58.8	64.3		
		Triple flash random	165	179	64.7	70.2		
		Spikes	180	194	70.6	76.1		
		Lightning	195	209	76.5	82.0		
		Random pixel flash	210	224	82.4	87.8		
		Random fixture flash	225	239	88.2	93.7		
		Flash offset between fixtures (adjust offset on Global flash rate channel)	240	247	94.1	96.9		
Random pattern	248	251	97.3	98.4				
Random pixel	252	255	98.8	100				



18	CTC (RGB)	Open	0	10	0	3.9	0	Snap
		10 000 K	11	11	4.3	4.3		Fade
		...	12	254	4.7	99.2		
		2 500 K	255	255	100	100		
19	RGB strobe phase	RGB strobe phase shift 0 → 359° offset relative to White strobe	0	255	0	100	0	Fade

STROBE A Background color

20	Intensity backgd.	Intensity 0 → 100%	0	255	0	100	0	Fade
21	Red background	Intensity 0 → 100%	0	255	0	100	0	Fade
22	Green background	Intensity 0 → 100%	0	255	0	100	0	Fade
23	Blue background	Intensity 0 → 100%	0	255	0	100	0	Fade
24	White background	Intensity 0 → 100%	0	255	0	100	0	Fade

STROBE A RGB segments individual control (upper and lower halves controlled as one pixel)

25	Red segment 01	Red intensity 0 → 100%	0	255	0	100	0	Fade
26	Green segment 01	Green intensity 0 → 100%	0	255	0	100	0	Fade
27	Blue segment 01	Blue intensity 0 → 100%	0	255	0	100	0	Fade
28	Red segment 02	RGB segments in order, intensity 0 → 100%	0	255	0	100	0	Fade
...	...							
81	Blue segment 19							
82	Red segment 20	Red intensity 0 → 100%	0	255	0	100	0	Fade
83	Green segment 20	Green intensity 0 → 100%	0	255	0	100	0	Fade
84	Blue segment 20	Blue intensity 0 → 100%	0	255	0	100	0	Fade

STROBE B White strobe with FX patterns

85	White intensity coarse	White intensity 0 → 100% (16-bit)	0	65535	0	100	0	Fade
86	White intensity fine							
87	White flash duration	Flash duration short → long	0	255	0	100	0	Fade
88	White flash rate (Shutter)	Closed	0	4	0	1.6	0	Snap
		Flash rate slow → fast	5	250	2	97.6		Fade
		Open	251	255	98	100		Snap
89	White intensity effects (Strobe mode)	Off (normal sync flashes)	0	14	0	5.5	0	Snap
		Single flash if change on flash rate channel	15	29	5.9	11.4		
		Pulse	30	44	11.8	17.3		
		Pulse opening	45	59	17.6	23.1		
		Pulse closing	60	74	23.5	29.0		
		Pulse random	75	89	29.4	34.9		
		Pulse opening random	90	104	35.3	40.8		
		Pulse closing random	105	119	41.2	46.7		
		Double flash	120	134	47.1	52.5		
		Double flash random	135	149	52.9	58.4		
		Triple flash	150	164	58.8	64.3		
		Triple flash random	165	179	64.7	70.2		
		Spikes	180	194	70.6	76.1		
		Lightning	195	209	76.5	82.0		
		Random pixel flash	210	224	82.4	87.8		
		Random fixture flash	225	239	88.2	93.7		
Flash offset between fixtures (adjust offset on Global flash rate channel)	240	247	94.1	96.9				
Random pattern	248	251	97.3	98.4				
Random pixel	252	255	98.8	100				
90	No function							

91	White FX pattern select	Off (all white patterns inactive)	0	11	0	4.3	0	Snap
		Pattern 01	12	15	4.7	5.9		
		Patterns 02 ... 49		
		Pattern 50	208	211	81.6	82.8		
		No function	212	247	83.1	100		
92	White pattern step select / speed	Pattern step 01	0	2	0	0.8	0	Snap
		Pattern steps 02 ... 39		Snap
		Pattern step 40	117	119	45.9	46.7		Snap
		No function	120	127	47.1	49.8		Snap
		CW fast → slow (run pattern step 1 ... n)	128	190	50.2	74.5		Fade
		Stop	191	192	74.9	75.3		Snap
		CCW slow → fast (run pattern step n ... 1)	193	255	75.7	100		Fade
93	White pattern step crossfading	No crossfading, snap from one step to next	0	5	0	3.9	0	Snap
		Snap ... longest crossfade (fade in and fade out times are identical)	6	127	4.3	49.0		Fade
		No crossfading, snap from one step to next	128	133	49.4	51.0		Snap
		Snap → longest crossfade with tail (fade-in time is shorter than fade out time, creates a shadow effect)	134	255	51.4	100		Fade
94	White pattern transition	No transition time, snap from one pattern to next	0	10	0	3.9	0	Snap
		Snap → 15 sec. transition time	11	68	4.3	26.7		Fade
		No transition time, snap from one pattern to next	69	73	27.1	28.6		Snap
		FOB (Fade Over Blackout) transition, Snap → 15 sec. transition time	74	130	29.0	51.0		Fade
		No transition time, snap from one pattern to next	131	135	51.4	52.9		Snap
		FOF (Fade Over Full) transition, Snap → 15 sec. transition time	136	193	53.3	75.7		Fade
		No function	194	255	76.1	100		
95	White pattern chain length	Off (no chain)	0	0	0	0	0	Snap
		Total length of pattern chain: 1 → 255 fixtures	1	255	0.4	100		Fade
96	White pattern position in chain	Off (no chain)	0	0	0	0	0	Snap
		Fixture is number 1 → number 255 in the chain	1	255	0.4	100		Fade

STROBE B RGB segments overall control

97	RGB intensity coarse	Intensity 0 → 100% (16-bit)	0	65535	0	100	0	Fade
98	RGB intensity fine							
99	RGB duration	Flash duration short → long	0	255	0	100	0	Fade
100	RGB flash rate (Shutter)	Closed	0	4	0	1.6	0	Snap
		Flash rate slow → fast	5	250	2	97.6		Fade
		Open	251	255	98	100		Snap
101	RGB strobe intensity effects (Strobe mode)	Off (normal sync flashes)	0	14	0	5.5	0	Snap
		Single flash if change on flash rate channel	15	29	5.9	11.4		
		Pulse	30	44	11.8	17.3		
		Pulse opening	45	59	17.6	23.1		
		Pulse closing	60	74	23.5	29.0		
		Pulse random	75	89	29.4	34.9		
		Pulse opening random	90	104	35.3	40.8		
Pulse closing random	105	119	41.2	46.7				



		Double flash	120	134	47.1	52.5		
		Double flash random	135	149	52.9	58.4		
		Triple flash	150	164	58.8	64.3		
		Triple flash random	165	179	64.7	70.2		
		Spikes	180	194	70.6	76.1		
		Lightning	195	209	76.5	82.0		
		Random pixel flash	210	224	82.4	87.8		
		Random fixture flash	225	239	88.2	93.7		
		Flash offset between fixtures (adjust offset on Global flash rate channel)	240	247	94.1	96.9		
		Random pattern	248	251	97.3	98.4		
		Random pixel	252	255	98.8	100		
102	CTC (RGB)	Open	0	10	0	3.9	0	Snap
		10 000 K	11	11	4.3	4.3		Fade
		...	12	254	4.7	99.2		
		2 500 K	255	255	100	100		
103	RGB strobe phase	RGB strobe phase shift 0 → 359° offset relative to White strobe	0	255	0	100	0	Fade

STROBE B Background color

104	Intensity backgd.	Intensity 0 → 100%	0	255	0	100	0	Fade
105	Red background	Intensity 0 → 100%	0	255	0	100	0	Fade
106	Green background	Intensity 0 → 100%	0	255	0	100	0	Fade
107	Blue background	Intensity 0 → 100%	0	255	0	100	0	Fade
108	White background	Intensity 0 → 100%	0	255	0	100	0	Fade

STROBE B RGB segments individual control (upper and lower halves controlled as one pixel)

109	Red segment 01	Red intensity 0 → 100%	0	255	0	100	0	Fade
110	Green segment 01	Green intensity 0 → 100%	0	255	0	100	0	Fade
111	Blue segment 01	Blue intensity 0 → 100%	0	255	0	100	0	Fade
112	Red segment 02	RGB segments in order, intensity 0 → 100%	0	255	0	100	0	Fade
...	...							
165	Blue segment 19							
166	Red segment 20	Red intensity 0 → 100%	0	255	0	100	0	Fade
167	Green segment 20	Green intensity 0 → 100%	0	255	0	100	0	Fade
168	Blue segment 20	Blue intensity 0 → 100%	0	255	0	100	0	Fade

DMX Mode 4: White + RGB Strobes + W Pixel

94 DMX Channels

Channel	Command	DMX range	Percent %	Default DMX	Fade			
STROBE A White segments overall control								
1	Global intensity coarse	Overall intensity 0 → 100% (16-bit)	0	65535	0	100	0	Fade
2	Global intensity fine							
3	Global duration	Flash duration short → long	0	255	0	100	0	Fade
4	Global flash rate (Shutter)	Closed	0	4	0	1.6	0	Snap
		Flash rate slow → fast	5	250	2	97.6		Fade
		Open	251	255	98	100		Snap
5	Global intensity effects (Strobe mode)	Off (normal sync flashes)	0	14	0	5.5	0	Snap
		Single flash if change on flash rate channel	15	29	5.9	11.4		
		Pulse	30	44	11.8	17.3		
		Pulse opening	45	59	17.6	23.1		
		Pulse closing	60	74	23.5	29.0		
		Pulse random	75	89	29.4	34.9		
		Pulse opening random	90	104	35.3	40.8		
		Pulse closing random	105	119	41.2	46.7		
		Double flash	120	134	47.1	52.5		
		Double flash random	135	149	52.9	58.4		
		Triple flash	150	164	58.8	64.3		
		Triple flash random	165	179	64.7	70.2		
		Spikes	180	194	70.6	76.1		
		Lightning	195	209	76.5	82.0		
		Random pixel flash	210	224	82.4	87.8		
Random fixture flash	225	239	88.2	93.7				
	Flash offset between fixtures (adjust offset on Global flash rate channel)	240	255	94.1	100			
6	Control /Settings	See 'Control / Settings channel' on page 65						

STROBE A RGB strobe with FX patterns

7	RGB intensity coarse	RGB intensity 0 → 100% (16-bit)	0	65535	0	100	0	Fade
8	RGB intensity fine							
9	RGB duration	Flash duration short → long	0	255	0	100	0	Fade
10	RGB flash rate (Shutter)	Closed	0	4	0	1.6	0	Snap
		Flash rate slow → fast	5	250	2	97.6		Fade
		Open	251	255	98	100		Snap



11	RGB intensity effects (Strobe mode)	Off (normal sync flashes)	0	14	0	5.5	0	Snap
		Single flash if change on flash rate channel	15	29	5.9	11.4		
		Pulse	30	44	11.8	17.3		
		Pulse opening	45	59	17.6	23.1		
		Pulse closing	60	74	23.5	29.0		
		Pulse random	75	89	29.4	34.9		
		Pulse opening random	90	104	35.3	40.8		
		Pulse closing random	105	119	41.2	46.7		
		Double flash	120	134	47.1	52.5		
		Double flash random	135	149	52.9	58.4		
		Triple flash	150	164	58.8	64.3		
		Triple flash random	165	179	64.7	70.2		
		Spikes	180	194	70.6	76.1		
		Lightning	195	209	76.5	82.0		
		Random pixel flash	210	224	82.4	87.8		
Random fixture flash	225	239	88.2	93.7				
Flash offset between fixtures (adjust offset on Global flash rate channel)	240	255	94.1	100				
12	CTC	Open	0	10	0	3.9	0	Snap
		10 000 K	11	11	4.3	4.3		Fade
		...	12	254	4.7	99.2		
		2 500 K	255	255	100	100		
13	Red	Intensity 0 → 100%	0	255	0	100	0	Fade
14	Green	Intensity 0 → 100%	0	255	0	100	0	Fade
15	Blue	Intensity 0 → 100%	0	255	0	100	0	Fade
16	RGB FX pattern select	Off (all white patterns inactive)	0	11	0	4.3	0	Snap
		Pattern 01	12	15	4.7	5.9		
		Patterns 02 ... 49		
		Pattern 50	208	211	81.6	82.8		
		No function	212	247	83.1	100		
17	RGB pattern step select / speed	Pattern step 01	0	2	0	0.8	0	Snap
		Pattern steps 02 ... 39		Snap
		Pattern step 40	117	119	45.9	46.7		Snap
		No function	120	127	47.1	49.8		Snap
		CW fast → slow (run pattern step 1 ... n)	128	190	50.2	74.5		Fade
		Stop	191	192	74.9	75.3		Snap
		CCW slow → fast (run pattern step n ... 1)	193	255	75.7	100		Fade
18	RGB pattern step crossfading	No crossfading, snap from one step to next	0	5	0	3.9	0	Snap
		Snap → longest crossfade (fade in and fade out times are identical)	6	127	4.3	49.0		Fade
		No crossfading, snap from one step to next	128	133	49.4	51.0		Snap
		Snap → longest crossfade with tail (fade-in time is shorter than fade out time, creates a shadow effect)	134	255	51.4	100		Fade

19	RGB pattern transition	No transition time, snap from one pattern to next	0	10	0	3.9	0	Snap
		Snap → 15 sec. transition time	11	68	4.3	26.7		Fade
		No transition time, snap from one pattern to next	69	73	27.1	28.6		Snap
		FOB (Fade Over Blackout) transition, Snap → 15 sec. transition time	74	130	29.0	51.0		Fade
		No transition time, snap from one pattern to next	131	135	51.4	52.9		Snap
		FOF (Fade Over Full) transition, Snap → 15 sec. transition time	136	193	53.3	75.7		Fade
		No function	194	255	76.1	100		
20	RGB pattern chain length	Off (no chain)	0	0	0	0	0	Snap
		Total length of pattern chain: 1 → 255 fixtures	1	255	0.4	100		Fade
21	Position in chain	Off (no chain)	0	0	0	0	0	Snap
		Fixture is number 1 → number 255 in the chain	1	255	0.4	100		Fade
22	RGB strobe phase	RGB strobe timing shift 0 → 359° offset relative to White strobe	0	255	0	100	0	Fade

STROBE A Background color

23	Intensity backgnd.	Intensity 0 → 100%	0	255	0	100	0	Fade
24	Red background	Intensity 0 → 100%	0	255	0	100	0	Fade
25	Green background	Intensity 0 → 100%	0	255	0	100	0	Fade
26	Blue background	Intensity 0 → 100%	0	255	0	100	0	Fade
27	White background	Intensity 0 → 100%	0	255	0	100	0	Fade

STROBE A White segments individual control

28	White segment 01	White intensity 0 → 100%	0	255	0	100	0	Fade
29	White segment 02	White segments in order: intensity 0 → 100%	0	255	0	100	0	Fade
46	White segment 19							
47	White segment 20	White intensity 0 → 100%	0	255	0	100	0	Fade

STROBE B White segments overall control

48	Global intensity coarse	Overall intensity 0 → 100% (16-bit)	0	65535	0	100	0	Fade
49	Global intensity fine							
50	Global duration	Flash duration short → long	0	255	0	100	0	Fade
51	Global flash rate (Shutter)	Closed	0	4	0	1.6	0	Snap
		Flash rate slow → fast	5	250	2	97.6		Fade
		Open	251	255	98	100		Snap



52	Global intensity effects (Strobe mode)	Off (normal sync flashes)	0	14	0	5.5	0	Snap
		Single flash if change on flash rate channel	15	29	5.9	11.4		
		Pulse	30	44	11.8	17.3		
		Pulse opening	45	59	17.6	23.1		
		Pulse closing	60	74	23.5	29.0		
		Pulse random	75	89	29.4	34.9		
		Pulse opening random	90	104	35.3	40.8		
		Pulse closing random	105	119	41.2	46.7		
		Double flash	120	134	47.1	52.5		
		Double flash random	135	149	52.9	58.4		
		Triple flash	150	164	58.8	64.3		
		Triple flash random	165	179	64.7	70.2		
		Spikes	180	194	70.6	76.1		
		Lightning	195	209	76.5	82.0		
		Random pixel flash	210	224	82.4	87.8		
		Random fixture flash	225	239	88.2	93.7		
Flash offset between fixtures (adjust offset on Global flash rate channel)	240	255	94.1	100				
53	No function							

STROBE B RGB strobe with FX patterns

54	RGB intensity coarse	RGB intensity 0 → 100% (16-bit)	0	65535	0	100	0	Fade
55	RGB intensity fine							
56	RGB duration	Flash duration short → long	0	255	0	100	0	Fade
57	RGB flash rate (Shutter)	Closed	0	4	0	1.6	0	Snap
		Flash rate slow → fast	5	250	2	97.6		Fade
		Open	251	255	98	100		Snap
58	RGB intensity effects (Strobe mode)	Off (normal sync flashes)	0	14	0	5.5	0	Snap
		Single flash if change on flash rate channel	15	29	5.9	11.4		
		Pulse	30	44	11.8	17.3		
		Pulse opening	45	59	17.6	23.1		
		Pulse closing	60	74	23.5	29.0		
		Pulse random	75	89	29.4	34.9		
		Pulse opening random	90	104	35.3	40.8		
		Pulse closing random	105	119	41.2	46.7		
		Double flash	120	134	47.1	52.5		
		Double flash random	135	149	52.9	58.4		
		Triple flash	150	164	58.8	64.3		
		Triple flash random	165	179	64.7	70.2		
		Spikes	180	194	70.6	76.1		
		Lightning	195	209	76.5	82.0		
		Random pixel flash	210	224	82.4	87.8		
		Random fixture flash	225	239	88.2	93.7		
Flash offset between fixtures (adjust offset on Global flash rate channel)	240	255	94.1	100				
59	CTC	Open	0	10	0	3.9	0	Snap
		10 000 K	11	11	4.3	4.3		Fade
		...	12	254	4.7	99.2		
		2 500 K	255	255	100	100		
60	Red	Intensity 0 → 100%	0	255	0	100	0	Fade
61	Green	Intensity 0 → 100%	0	255	0	100	0	Fade
62	Blue	Intensity 0 → 100%	0	255	0	100	0	Fade

63	RGB FX pattern select	Off (all white patterns inactive)	0	11	0	4.3	0	Snap
		Pattern 01	12	15	4.7	5.9		
		Patterns 02 ... 49		
		Pattern 50	208	211	81.6	82.8		
		No function	212	247	83.1	100		
64	RGB pattern step select / speed	Pattern step 01	0	2	0	0.8	0	Snap
		Pattern steps 02 ... 39		Snap
		Pattern step 40	117	119	45.9	46.7		Snap
		No function	120	127	47.1	49.8		Snap
		CW fast → slow (run pattern step 1 ... n)	128	190	50.2	74.5		Fade
		Stop	191	192	74.9	75.3		Snap
		CCW slow → fast (run pattern step n ... 1)	193	255	75.7	100		Fade
65	RGB pattern step crossfading	No crossfading, snap from one step to next	0	5	0	3.9	0	Snap
		Snap → longest crossfade (fade in and fade out times are identical)	6	127	4.3	49.0		Fade
		No crossfading, snap from one step to next	128	133	49.4	51.0		Snap
		Snap → longest crossfade with tail (fade-in time is shorter than fade out time, creates a shadow effect)	134	255	51.4	100		Fade
66	RGB pattern transition	No transition time, snap from one pattern to next	0	10	0	3.9	0	Snap
		Snap → 15 sec. transition time	11	68	4.3	26.7		Fade
		No transition time, snap from one pattern to next	69	73	27.1	28.6		Snap
		FOB (Fade Over Blackout) transition, Snap → 15 sec. transition time	74	130	29.0	51.0		Fade
		No transition time, snap from one pattern to next	131	135	51.4	52.9		Snap
		FOF (Fade Over Full) transition, Snap → 15 sec. transition time	136	193	53.3	75.7		Fade
		No function	194	255	76.1	100		
67	RGB pattern chain length	Off (no chain)	0	0	0	0	0	Snap
		Total length of pattern chain: 1 → 255 fixtures	1	255	0.4	100		Fade
68	Position in chain	Off (no chain)	0	0	0	0	0	Snap
		Fixture is number 1 → number 255 in the chain	1	255	0.4	100		Fade
69	RGB strobe phase	RGB strobe timing shift 0 → 359° offset relative to White strobe	0	255	0	100	0	Fade

STROBE B Background color

70	Intensity backgd.	Intensity 0 → 100%	0	255	0	100	0	Fade
71	Red background	Intensity 0 → 100%	0	255	0	100	0	Fade
72	Green background	Intensity 0 → 100%	0	255	0	100	0	Fade
73	Blue background	Intensity 0 → 100%	0	255	0	100	0	Fade
74	White background	Intensity 0 → 100%	0	255	0	100	0	Fade

STROBE B White segments individual control

75	White segment 01	White intensity 0 → 100%	0	255	0	100	0	Fade
76	White segment 02	White segments in order: intensity 0 → 100%	0	255	0	100	0	Fade
...	...							
93	White segment 19							
94	White segment 20	White intensity 0 → 100%	0	255	0	100	0	Fade



DMX Mode 5: Multipix

196 DMX Channels

Channel	Command		DMX range	Percent %	Default DMX	Fade		
STROBE A White segments overall control								
1	White intensity coarse	White intensity 0 → 100% (16-bit)	0	65535	0	100	0	Fade
2	White intensity fine							
3	White duration	Flash duration short → long	0	255	0	100	0	Fade
4	White flash rate (Shutter)	Closed	0	4	0	1.6	0	Snap
		Flash rate slow → fast	5	250	2	97.6		Fade
		Open	251	255	98	100		Snap
5	White intensity effects (Strobe mode)	Off (normal sync flashes)	0	14	0	5.5	0	Snap
		Single flash if change on flash rate channel	15	29	5.9	11.4		
		Pulse	30	44	11.8	17.3		
		Pulse opening	45	59	17.6	23.1		
		Pulse closing	60	74	23.5	29.0		
		Pulse random	75	89	29.4	34.9		
		Pulse opening random	90	104	35.3	40.8		
		Pulse closing random	105	119	41.2	46.7		
		Double flash	120	134	47.1	52.5		
		Double flash random	135	149	52.9	58.4		
		Triple flash	150	164	58.8	64.3		
		Triple flash random	165	179	64.7	70.2		
		Spikes	180	194	70.6	76.1		
		Lightning	195	209	76.5	82.0		
		Random pixel flash	210	224	82.4	87.8		
Random fixture flash	225	239	88.2	93.7				
	Flash offset between fixtures (adjust offset on Global flash rate channel)	240	255	94.1	100			
6	Control /Settings	See 'Control / Settings channel' on page 65						

STROBE A RGB segments overall control

7	RGB intensity coarse	RGB intensity 0 → 100% (16-bit)	0	65535	0	100	0	Fade
8	RGB intensity fine							
9	RGB duration	Flash duration short → long	0	255	0	100	0	Fade
10	RGB flash rate (Shutter)	Closed	0	4	0	1.6	0	Snap
		Flash rate slow → fast	5	250	2	97.6		Fade
		Open	251	255	98	100		Snap

11	RGB intensity effects (Strobe mode)	Off (normal sync flashes)	0	14	0	5.5	0	Snap
		Single flash if change on flash rate channel	15	29	5.9	11.4		
		Pulse	30	44	11.8	17.3		
		Pulse opening	45	59	17.6	23.1		
		Pulse closing	60	74	23.5	29.0		
		Pulse random	75	89	29.4	34.9		
		Pulse opening random	90	104	35.3	40.8		
		Pulse closing random	105	119	41.2	46.7		
		Double flash	120	134	47.1	52.5		
		Double flash random	135	149	52.9	58.4		
		Triple flash	150	164	58.8	64.3		
		Triple flash random	165	179	64.7	70.2		
		Spikes	180	194	70.6	76.1		
		Lightning	195	209	76.5	82.0		
		Random pixel flash	210	224	82.4	87.8		
Random fixture flash	225	239	88.2	93.7				
Flash offset between fixtures (adjust offset on Global flash rate channel)	240	255	94.1	100				
12	RGB CTC	Open	0	10	0	3.9	0	Snap
		10 000 K	11	11	4.3	4.3		Fade
		...	12	254	4.7	99.2		
		2 500 K	255	255	100	100		
13	RGB strobe phase	RGB strobe phase shift 0 → 359° offset relative to White strobe	0	255	0	100	0	Fade

STROBE A Background color

14	Intensity backgnd.	Intensity 0 → 100%	0	255	0	100	0	Fade
15	Red background	Intensity 0 → 100%	0	255	0	100	0	Fade
16	Green background	Intensity 0 → 100%	0	255	0	100	0	Fade
17	Blue background	Intensity 0 → 100%	0	255	0	100	0	Fade
18	White background	Intensity 0 → 100%	0	255	0	100	0	Fade

STROBE A White segments individual control

19	White segment 01	White intensity 0 → 100%	0	255	0	100	0	Fade
20	White segment 02	White segments in order: intensity 0 → 100%	0	255	0	100	0	Fade
...	...							
37	White segment 19							
38	White segment 20	White intensity 0 → 100%	0	255	0	100	0	Fade

STROBE A RGB segments individual control (upper and lower halves controlled as one pixel)

39	Red segment 01	Red intensity 0 → 100%	0	255	0	100	0	Fade
40	Green segment 01	Green intensity 0 → 100%	0	255	0	100	0	Fade
41	Blue segment 01	Blue intensity 0 → 100%	0	255	0	100	0	Fade
42	Red segment 02	RGB segments in order, intensity 0 → 100%	0	255	0	100	0	Fade
...	...							
95	Blue segment 19							
96	Red segment 20	Red intensity 0 → 100%	0	255	0	100	0	Fade
97	Green segment 20	Green intensity 0 → 100%	0	255	0	100	0	Fade
98	Blue segment 20	Blue intensity 0 → 100%	0	255	0	100	0	Fade

STROBE B White segments overall control

99	White intensity coarse	White intensity 0 → 100% (16-bit)	0	65535	0	100	0	Fade
100	White intensity fine							
101	White duration	Flash duration short → long	0	255	0	100	0	Fade
102	White flash rate (Shutter)	Closed	0	4	0	1.6	0	Snap
		Flash rate slow → fast	5	250	2	97.6		Fade
		Open	251	255	98	100		Snap



103	White intensity effects (Strobe mode)	Off (normal sync flashes)	0	14	0	5.5	0	Snap
		Single flash if change on flash rate channel	15	29	5.9	11.4		
		Pulse	30	44	11.8	17.3		
		Pulse opening	45	59	17.6	23.1		
		Pulse closing	60	74	23.5	29.0		
		Pulse random	75	89	29.4	34.9		
		Pulse opening random	90	104	35.3	40.8		
		Pulse closing random	105	119	41.2	46.7		
		Double flash	120	134	47.1	52.5		
		Double flash random	135	149	52.9	58.4		
		Triple flash	150	164	58.8	64.3		
		Triple flash random	165	179	64.7	70.2		
		Spikes	180	194	70.6	76.1		
		Lightning	195	209	76.5	82.0		
		Random pixel flash	210	224	82.4	87.8		
Random fixture flash	225	239	88.2	93.7				
Flash offset between fixtures (adjust offset on Global flash rate channel)	240	255	94.1	100				
104	No function							

STROBE B RGB segments overall control

105	RGB intensity coarse	RGB intensity 0 → 100% (16-bit)	0	65535	0	100	0	Fade
106	RGB intensity fine							
107	RGB duration	Flash duration short → long	0	255	0	100	0	Fade
108	RGB flash rate (Shutter)	Closed	0	4	0	1.6	0	Snap
		Flash rate slow → fast	5	250	2	97.6		Fade
		Open	251	255	98	100		Snap
109	RGB intensity effects (Strobe mode)	Off (normal sync flashes)	0	14	0	5.5	0	Snap
		Single flash if change on flash rate channel	15	29	5.9	11.4		
		Pulse	30	44	11.8	17.3		
		Pulse opening	45	59	17.6	23.1		
		Pulse closing	60	74	23.5	29.0		
		Pulse random	75	89	29.4	34.9		
		Pulse opening random	90	104	35.3	40.8		
		Pulse closing random	105	119	41.2	46.7		
		Double flash	120	134	47.1	52.5		
		Double flash random	135	149	52.9	58.4		
		Triple flash	150	164	58.8	64.3		
		Triple flash random	165	179	64.7	70.2		
		Spikes	180	194	70.6	76.1		
		Lightning	195	209	76.5	82.0		
		Random pixel flash	210	224	82.4	87.8		
Random fixture flash	225	239	88.2	93.7				
Flash offset between fixtures (adjust offset on Global flash rate channel)	240	255	94.1	100				
110	RGB CTC	Open	0	10	0	3.9	0	Snap
		10 000 K	11	11	4.3	4.3		Fade
		...	12	254	4.7	99.2		
		2 500 K	255	255	100	100		
111	RGB strobe phase	RGB strobe phase shift 0 → 359° offset relative to White strobe	0	255	0	100	0	Fade

STROBE B Background color

112	Intensity backgnd.	Intensity 0 → 100%	0	255	0	100	0	Fade
113	Red background	Intensity 0 → 100%	0	255	0	100	0	Fade
114	Green background	Intensity 0 → 100%	0	255	0	100	0	Fade
115	Blue background	Intensity 0 → 100%	0	255	0	100	0	Fade
116	White background	Intensity 0 → 100%	0	255	0	100	0	Fade

STROBE B White segments individual control

117	White segment 01	White intensity 0 → 100%	0	255	0	100	0	Fade
118	White segment 02	White segments in order: intensity 0 → 100%	0	255	0	100	0	Fade
...	...							
135	White segment 19							
136	White segment 20	White intensity 0 → 100%	0	255	0	100	0	Fade

STROBE B RGB segments individual control (upper and lower halves controlled as one pixel)

137	Red segment 01	Red intensity 0 → 100%	0	255	0	100	0	Fade
138	Green segment 01	Green intensity 0 → 100%	0	255	0	100	0	Fade
139	Blue segment 01	Blue intensity 0 → 100%	0	255	0	100	0	Fade
140	Red segment 02	RGB segments in order, intensity 0 → 100%	0	255	0	100	0	Fade
...	...							
193	Blue segment 19							
194	Red segment 20	Red intensity 0 → 100%	0	255	0	100	0	Fade
195	Green segment 20	Green intensity 0 → 100%	0	255	0	100	0	Fade
196	Blue segment 20	Blue intensity 0 → 100%	0	255	0	100	0	Fade



DMX Mode 6: Multipix Advanced

316 DMX Channels

Channel	Command	DMX range	Percent %	Default DMX	Fade
---------	---------	-----------	-----------	-------------	------

STROBE A White segments overall control

1	White intensity coarse	White intensity 0 → 100% (16-bit)	0	65535	0	100	0	Fade
2	White intensity fine							
3	White duration	Flash duration short → long	0	255	0	100	0	Fade
4	White flash rate (Shutter)	Closed	0	4	0	1.6	0	Snap
		Flash rate slow → fast	5	250	2	97.6		Fade
		Open	251	255	98	100		Snap
5	White intensity effects (Strobe mode)	Off (normal sync flashes)	0	14	0	5.5	0	Snap
		Single flash if change on flash rate channel	15	29	5.9	11.4		
		Pulse	30	44	11.8	17.3		
		Pulse opening	45	59	17.6	23.1		
		Pulse closing	60	74	23.5	29.0		
		Pulse random	75	89	29.4	34.9		
		Pulse opening random	90	104	35.3	40.8		
		Pulse closing random	105	119	41.2	46.7		
		Double flash	120	134	47.1	52.5		
		Double flash random	135	149	52.9	58.4		
		Triple flash	150	164	58.8	64.3		
		Triple flash random	165	179	64.7	70.2		
		Spikes	180	194	70.6	76.1		
		Lightning	195	209	76.5	82.0		
		Random pixel flash	210	224	82.4	87.8		
Random fixture flash	225	239	88.2	93.7				
	Flash offset between fixtures (adjust offset on Global flash rate channel)	240	255	94.1	100			
6	Control /Settings	See 'Control / Settings channel' on page 65						

STROBE A RGB segments overall control

7	RGB intensity coarse	RGB intensity 0 → 100% (16-bit)	0	65535	0	100	0	Fade
8	RGB intensity fine							
9	RGB flash duration	Flash duration short → long	0	255	0	100	0	Fade
10	RGB flash rate (Shutter)	Closed	0	4	0	1.6	0	Snap
		Flash rate slow → fast	5	250	2	97.6		Fade
		Open	251	255	98	100		Snap

11	RGB intensity effects / Strobe mode	Off (normal sync flashes)	0	14	0	5.5	0	Snap
		Single flash if change on flash rate channel	15	29	5.9	11.4		
		Pulse	30	44	11.8	17.3		
		Pulse opening	45	59	17.6	23.1		
		Pulse closing	60	74	23.5	29.0		
		Pulse random	75	89	29.4	34.9		
		Pulse opening random	90	104	35.3	40.8		
		Pulse closing random	105	119	41.2	46.7		
		Double flash	120	134	47.1	52.5		
		Double flash random	135	149	52.9	58.4		
		Triple flash	150	164	58.8	64.3		
		Triple flash random	165	179	64.7	70.2		
		Spikes	180	194	70.6	76.1		
		Lightning	195	209	76.5	82.0		
		Random pixel flash	210	224	82.4	87.8		
Random fixture flash	225	239	88.2	93.7				
Flash offset between fixtures (adjust offset on Global flash rate channel)	240	255	94.1	100				
12	RGB CTC	Open	0	10	0	3.9	0	Snap
		10 000 K	11	11	4.3	4.3		Fade
		...	12	254	4.7	99.2		
		2 500 K	255	255	100	100		
13	RGB strobe phase	RGB strobe phase shift 0 → 359° offset relative to White strobe	0	255	0	100	0	Fade

STROBE A Background color

14	Intensity background	Intensity 0 → 100%	0	255	0	100	0	Fade
15	Red background	Intensity 0 → 100%	0	255	0	100	0	Fade
16	Green background	Intensity 0 → 100%	0	255	0	100	0	Fade
17	Blue background	Intensity 0 → 100%	0	255	0	100	0	Fade
18	White background	Intensity 0 → 100%	0	255	0	100	0	Fade

STROBE A White segments individual control

19	White segment 01	White intensity 0 → 100%	0	255	0	100	0	Fade
20	White segment 02	White segments in order: intensity 0 → 100%	0	255	0	100	0	Fade
...	...							
37	White segment 19							
38	White segment 20	White intensity 0 → 100%	0	255	0	100	0	Fade

STROBE A RGB segments individual control (upper and lower halves controlled separately)

39	Red segment upper 01	Red intensity 0 → 100%	0	255	0	100	0	Fade
40	Green segment upper 01	Green intensity 0 → 100%	0	255	0	100	0	Fade
41	Blue segment upper 01	Blue intensity 0 → 100%	0	255	0	100	0	Fade
42	Red segt. upper 02	RGB segments upper halves in order, intensity 0-100%	0	255	0	100	0	Fade
...	...							
98	Blue segt. upper 20							
99	Red segt. lower 21	RGB segments lower halves in order, intensity 0-100%	0	255	0	100	0	Fade
...	...							
155	Blue segt. lower 39							
156	Red segment lower 40	Red intensity 0-100%	0	255	0	100	0	Fade
157	Green segment lower 40	Green intensity 0-100%	0	255	0	100	0	Fade
158	Blue segment lower 40	Blue intensity 0-100%	0	255	0	100	0	Fade



STROBE B White segments overall control

159	White intensity coarse	White intensity 0 → 100% (16-bit)	0	65535	0	100	0	Fade
160	White intensity fine							
161	White duration	Flash duration short → long	0	255	0	100	0	Fade
162	White flash rate (Shutter)	Closed	0	4	0	1.6	0	Snap
		Flash rate slow → fast	5	250	2	97.6		Fade
		Open	251	255	98	100		Snap
163	White intensity effects (Strobe mode)	Off (normal sync flashes)	0	14	0	5.5	0	Snap
		Single flash if change on flash rate channel	15	29	5.9	11.4		
		Pulse	30	44	11.8	17.3		
		Pulse opening	45	59	17.6	23.1		
		Pulse closing	60	74	23.5	29.0		
		Pulse random	75	89	29.4	34.9		
		Pulse opening random	90	104	35.3	40.8		
		Pulse closing random	105	119	41.2	46.7		
		Double flash	120	134	47.1	52.5		
		Double flash random	135	149	52.9	58.4		
		Triple flash	150	164	58.8	64.3		
		Triple flash random	165	179	64.7	70.2		
		Spikes	180	194	70.6	76.1		
		Lightning	195	209	76.5	82.0		
		Random pixel flash	210	224	82.4	87.8		
Random fixture flash	225	239	88.2	93.7				
	Flash offset between fixtures (adjust offset on Global flash rate channel)	240	255	94.1	100			
164	No function							

STROBE B RGB segments overall control

165	RGB intensity coarse	RGB intensity 0 → 100% (16-bit)	0	65535	0	100	0	Fade
166	RGB intensity fine							
167	RGB flash duration	Flash duration short → long	0	255	0	100	0	Fade
168	RGB flash rate (Shutter)	Closed	0	4	0	1.6	0	Snap
		Flash rate slow → fast	5	250	2	97.6		Fade
		Open	251	255	98	100		Snap
169	RGB intensity effects / Strobe mode	Off (normal sync flashes)	0	14	0	5.5	0	Snap
		Single flash if change on flash rate channel	15	29	5.9	11.4		
		Pulse	30	44	11.8	17.3		
		Pulse opening	45	59	17.6	23.1		
		Pulse closing	60	74	23.5	29.0		
		Pulse random	75	89	29.4	34.9		
		Pulse opening random	90	104	35.3	40.8		
		Pulse closing random	105	119	41.2	46.7		
		Double flash	120	134	47.1	52.5		
		Double flash random	135	149	52.9	58.4		
		Triple flash	150	164	58.8	64.3		
		Triple flash random	165	179	64.7	70.2		
		Spikes	180	194	70.6	76.1		
		Lightning	195	209	76.5	82.0		
		Random pixel flash	210	224	82.4	87.8		
Random fixture flash	225	239	88.2	93.7				
	Flash offset between fixtures (adjust offset on Global flash rate channel)	240	255	94.1	100			

170	RGB CTC	Open	0	10	0	3.9	0	Snap
		10 000 K	11	11	4.3	4.3		Fade
		...	12	254	4.7	99.2		
		2 500 K	255	255	100	100		
171	RGB strobe phase	RGB strobe phase shift 0 → 359° offset relative to White strobe	0	255	0	100	0	Fade

STROBE B Background color

172	Intensity backnd.	Intensity 0 → 100%	0	255	0	100	0	Fade
173	Red background	Intensity 0 → 100%	0	255	0	100	0	Fade
174	Green background	Intensity 0 → 100%	0	255	0	100	0	Fade
175	Blue background	Intensity 0 → 100%	0	255	0	100	0	Fade
176	White background	Intensity 0 → 100%	0	255	0	100	0	Fade

STROBE B White segments individual control

177	White segment 01	White intensity 0 → 100%	0	255	0	100	0	Fade
178	White segment 02	White segments in order: intensity 0 → 100%	0	255	0	100	0	Fade
...	...							
195	White segment 19							
196	White segment 20	White intensity 0 → 100%	0	255	0	100	0	Fade

STROBE B RGB segments individual control (upper and lower halves controlled separately)

197	Red segment upper 01	Red intensity 0 → 100%	0	255	0	100	0	Fade
198	Green segment upper 01	Green intensity 0 → 100%	0	255	0	100	0	Fade
199	Blue segment upper 01	Blue intensity 0 → 100%	0	255	0	100	0	Fade
200	Red segt. upper 02	RGB segments upper halves in order, intensity 0-100%	0	255	0	100	0	Fade
...	...							
256	Blue segt. upper 20							
257	Red segt. lower 21	RGB segments lower halves in order, intensity 0-100%	0	255	0	100	0	Fade
...	...							
313	Blue segt. lower 39							
314	Red segment lower 40	Red intensity 0-100%	0	255	0	100	0	Fade
315	Green segment lower 40	Green intensity 0-100%	0	255	0	100	0	Fade
316	Blue segment lower 40	Blue intensity 0-100%	0	255	0	100	0	Fade



DMX Mode 7: Multipix Quadpix

76 DMX Channels

Channel	Command	DMX range	Percent %	Default DMX	Fade
---------	---------	-----------	-----------	-------------	------

STROBE A White segments overall control

1	White intensity coarse	White intensity 0 → 100% (16-bit)	0	65535	0	100	0	Fade
2	White intensity fine							
3	White duration	Flash duration short → long	0	255	0	100	0	Fade
4	White flash rate (Shutter)	Closed	0	4	0	1.6	0	Snap
		Flash rate slow → fast	5	250	2	97.6		Fade
		Open	251	255	98	100		Snap
5	White intensity effects (Strobe mode)	Off (normal sync flashes)	0	14	0	5.5	0	Snap
		Single flash if change on flash rate channel	15	29	5.9	11.4		
		Pulse	30	44	11.8	17.3		
		Pulse opening	45	59	17.6	23.1		
		Pulse closing	60	74	23.5	29.0		
		Pulse random	75	89	29.4	34.9		
		Pulse opening random	90	104	35.3	40.8		
		Pulse closing random	105	119	41.2	46.7		
		Double flash	120	134	47.1	52.5		
		Double flash random	135	149	52.9	58.4		
		Triple flash	150	164	58.8	64.3		
		Triple flash random	165	179	64.7	70.2		
		Spikes	180	194	70.6	76.1		
		Lightning	195	209	76.5	82.0		
		Random pixel flash	210	224	82.4	87.8		
Random fixture flash	225	239	88.2	93.7				
	Flash offset between fixtures (adjust offset on Global flash rate channel)	240	255	94.1	100			
6	Control /Settings	See 'Control / Settings channel' on page 65						

STROBE A RGB segments overall control

7	RGB intensity coarse	RGB intensity 0 → 100% (16-bit)	0	65535	0	100	0	Fade
8	RGB intensity fine							
9	RGB flash duration	Flash duration short → long	0	255	0	100	0	Fade
10	RGB flash rate (Shutter)	Closed	0	4	0	1.6	0	Snap
		Flash rate slow → fast	5	250	2	97.6		Fade
		Open	251	255	98	100		Snap

11	RGB intensity effects / Strobe mode	Off (normal sync flashes)	0	14	0	5.5	0	Snap
		Single flash if change on flash rate channel	15	29	5.9	11.4		
		Pulse	30	44	11.8	17.3		
		Pulse opening	45	59	17.6	23.1		
		Pulse closing	60	74	23.5	29.0		
		Pulse random	75	89	29.4	34.9		
		Pulse opening random	90	104	35.3	40.8		
		Pulse closing random	105	119	41.2	46.7		
		Double flash	120	134	47.1	52.5		
		Double flash random	135	149	52.9	58.4		
		Triple flash	150	164	58.8	64.3		
		Triple flash random	165	179	64.7	70.2		
		Spikes	180	194	70.6	76.1		
		Lightning	195	209	76.5	82.0		
		Random pixel flash	210	224	82.4	87.8		
Random fixture flash	225	239	88.2	93.7				
Flash offset between fixtures (adjust offset on Global flash rate channel)	240	255	94.1	100				
12	RGB CTC	Open	0	10	0	3.9	0	Snap
		10 000 K	11	11	4.3	4.3		Fade
		...	12	254	4.7	99.2		
		2 500 K	255	255	100	100		
13	RGB strobe phase	RGB strobe phase shift 0 → 359° offset relative to White strobe	0	255	0	100	0	Fade

STROBE A Background color

14	Intensity backgnd.	Intensity 0 → 100%	0	255	0	100	0	Fade
15	Red background	Intensity 0 → 100%	0	255	0	100	0	Fade
16	Green background	Intensity 0 → 100%	0	255	0	100	0	Fade
17	Blue background	Intensity 0 → 100%	0	255	0	100	0	Fade
18	White background	Intensity 0 → 100%	0	255	0	100	0	Fade

STROBE A White quad segments

19	White quad segment 1	Segments 1-4 White intensity 0 → 100%	0	255	0	100	0	Fade
20	White quad segment 2	Segments 5-8 White intensity 0 → 100%	0	255	0	100	0	Fade
21	White quad segment 3	Segments 9-12 White intensity 0 → 100%	0	255	0	100	0	Fade
22	White quad segment 4	Segments 13-16 White intensity 0 → 100%	0	255	0	100	0	Fade
23	White quad segment 5	Segments 17-20 White intensity 0 → 100%	0	255	0	100	0	Fade

STROBE A RGB quad segments

24	Red quad segment 1	Segments 1-4 Red intensity 0 → 100%	0	255	0	100	0	Fade
25	Green quad segment 1	Segments 1-4 Green intensity 0 → 100%	0	255	0	100	0	Fade
26	Blue quad segment 1	Segments 1-4 Blue intensity 0 → 100%	0	255	0	100	0	Fade
27	Red quad segment 2	Segments 5-8 Red intensity 0 → 100%	0	255	0	100	0	Fade
28	Green quad segment 2	Segments 5-8 Green intensity 0 → 100%	0	255	0	100	0	Fade
29	Blue quad segment 2	Segments 5-8 Blue intensity 0 → 100%	0	255	0	100	0	Fade



30	Red quad segment 3	Segments 9-12 Red intensity 0 → 100%	0	255	0	100	0	Fade
31	Green quad segment 3	Segments 9-12 Green intensity 0 → 100%	0	255	0	100	0	Fade
32	Blue quad segment 3	Segments 9-12 Blue intensity 0 → 100%	0	255	0	100	0	Fade
33	Red quad segment 4	Segments 13-16 Red intensity 0 → 100%	0	255	0	100	0	Fade
34	Green quad segment 4	Segments 13-16 Green intensity 0 → 100%	0	255	0	100	0	Fade
35	Blue quad segment 4	Segments 13-16 Blue intensity 0 → 100%	0	255	0	100	0	Fade
36	Red quad segment 5	Segments 17-20 Red intensity 0 → 100%	0	255	0	100	0	Fade
37	Green quad segment 5	Segments 17-20 Green intensity 0 → 100%	0	255	0	100	0	Fade
38	Blue quad segment 5	Segments 17-20 Blue intensity 0 → 100%	0	255	0	100	0	Fade

STROBE B White segments overall control

39	White intensity coarse	White intensity 0 → 100% (16-bit)	0	65535	0	100	0	Fade
40	White intensity fine							
41	White duration	Flash duration short → long	0	255	0	100	0	Fade
42	White flash rate (Shutter)	Closed	0	4	0	1.6	0	Snap
		Flash rate slow → fast	5	250	2	97.6		Fade
		Open	251	255	98	100		Snap
43	White intensity effects (Strobe mode)	Off (normal sync flashes)	0	14	0	5.5	0	Snap
		Single flash if change on flash rate channel	15	29	5.9	11.4		
		Pulse	30	44	11.8	17.3		
		Pulse opening	45	59	17.6	23.1		
		Pulse closing	60	74	23.5	29.0		
		Pulse random	75	89	29.4	34.9		
		Pulse opening random	90	104	35.3	40.8		
		Pulse closing random	105	119	41.2	46.7		
		Double flash	120	134	47.1	52.5		
		Double flash random	135	149	52.9	58.4		
		Triple flash	150	164	58.8	64.3		
		Triple flash random	165	179	64.7	70.2		
		Spikes	180	194	70.6	76.1		
		Lightning	195	209	76.5	82.0		
Random pixel flash	210	224	82.4	87.8				
Random fixture flash	225	239	88.2	93.7				
Flash offset between fixtures (adjust offset on Global flash rate channel)	240	255	94.1	100				
44	No function							

STROBE B RGB segments overall control

45	RGB intensity coarse	RGB intensity 0 → 100% (16-bit)	0	65535	0	100	0	Fade
46	RGB intensity fine							
47	RGB flash duration	Flash duration short → long	0	255	0	100	0	Fade
48	RGB flash rate (Shutter)	Closed	0	4	0	1.6	0	Snap
		Flash rate slow → fast	5	250	2	97.6		Fade
		Open	251	255	98	100		Snap

49	RGB intensity effects / Strobe mode	Off (normal sync flashes)	0	14	0	5.5	0	Snap
		Single flash if change on flash rate channel	15	29	5.9	11.4		
		Pulse	30	44	11.8	17.3		
		Pulse opening	45	59	17.6	23.1		
		Pulse closing	60	74	23.5	29.0		
		Pulse random	75	89	29.4	34.9		
		Pulse opening random	90	104	35.3	40.8		
		Pulse closing random	105	119	41.2	46.7		
		Double flash	120	134	47.1	52.5		
		Double flash random	135	149	52.9	58.4		
		Triple flash	150	164	58.8	64.3		
		Triple flash random	165	179	64.7	70.2		
		Spikes	180	194	70.6	76.1		
		Lightning	195	209	76.5	82.0		
		Random pixel flash	210	224	82.4	87.8		
Random fixture flash	225	239	88.2	93.7				
Flash offset between fixtures (adjust offset on Global flash rate channel)	240	255	94.1	100				
50	RGB CTC	Open	0	10	0	3.9	0	Snap
		10 000 K	11	11	4.3	4.3		Fade
		...	12	254	4.7	99.2		
		2 500 K	255	255	100	100		
51	RGB strobe phase	RGB strobe phase shift 0 → 359° offset relative to White strobe	0	255	0	100	0	Fade

STROBE B Background color

52	Intensity backgd.	Intensity 0 → 100%	0	255	0	100	0	Fade
53	Red background	Intensity 0 → 100%	0	255	0	100	0	Fade
54	Green background	Intensity 0 → 100%	0	255	0	100	0	Fade
55	Blue background	Intensity 0 → 100%	0	255	0	100	0	Fade
56	White background	Intensity 0 → 100%	0	255	0	100	0	Fade

STROBE B White quad segments

57	White quad segment 1	Segments 1-4 White intensity 0 → 100%	0	255	0	100	0	Fade
58	White quad segment 2	Segments 5-8 White intensity 0 → 100%	0	255	0	100	0	Fade
59	White quad segment 3	Segments 9-12 White intensity 0 → 100%	0	255	0	100	0	Fade
60	White quad segment 4	Segments 13-16 White intensity 0 → 100%	0	255	0	100	0	Fade
61	White quad segment 5	Segments 17-20 White intensity 0 → 100%	0	255	0	100	0	Fade

STROBE A RGB quad segments

62	Red quad segment 1	Segments 1-4 Red intensity 0 → 100%	0	255	0	100	0	Fade
63	Green quad segment 1	Segments 1-4 Green intensity 0 → 100%	0	255	0	100	0	Fade
64	Blue quad segment 1	Segments 1-4 Blue intensity 0 → 100%	0	255	0	100	0	Fade
65	Red quad segment 2	Segments 5-8 Red intensity 0 → 100%	0	255	0	100	0	Fade
66	Green quad segment 2	Segments 5-8 Green intensity 0 → 100%	0	255	0	100	0	Fade
67	Blue quad segment 2	Segments 5-8 Blue intensity 0 → 100%	0	255	0	100	0	Fade

68	Red quad segment 3	Segments 9-12 Red intensity 0 → 100%	0	255	0	100	0	Fade
69	Green quad segment 3	Segments 9-12 Green intensity 0 → 100%	0	255	0	100	0	Fade
70	Blue quad segment 3	Segments 9-12 Blue intensity 0 → 100%	0	255	0	100	0	Fade
71	Red quad segment 4	Segments 13-16 Red intensity 0 → 100%	0	255	0	100	0	Fade
72	Green quad segment 4	Segments 13-16 Green intensity 0 → 100%	0	255	0	100	0	Fade
73	Blue quad segment 4	Segments 13-16 Blue intensity 0 → 100%	0	255	0	100	0	Fade
74	Red quad segment 5	Segments 17-20 Red intensity 0 → 100%	0	255	0	100	0	Fade
75	Green quad segment 5	Segments 17-20 Green intensity 0 → 100%	0	255	0	100	0	Fade
76	Blue quad segment 5	Segments 17-20 Blue intensity 0 → 100%	0	255	0	100	0	Fade

Control / Settings channel

The Control / Settings commands listed below are available on Channel 6 in every DMX mode. They apply to both Strobe A and Strobe B.

Channel	Command	DMX range		Percent %		Default DMX	Fade
6	No function	0	11	0	4.3	0	Snap
	Dimmer curve: Soft / square law (3 sec.)	12	14	4.7	5.5		
	Dimmer curve: Linear (3 sec.)	15	17	5.9	6.7		
	No function	18	26	9.4	10.2		
	Display mode: Off (3 sec.)	27	29	10.6	11.4		
	Display mode: Auto (3 sec.)	30	32	11.8	12.6		
	Display mode: On (3 sec.)	33	35	12.9	13.7		
	No function	36	38	14.1	14.9		
	Display orientation: Normal (3 sec.)	39	41	15.3	16.1		
	Display orientation: Inverted (3 sec.)	42	44	16.5	17.3		
	Display orientation: Auto (3 sec.)	45	47	17.7	18.4		
	No function	48	50	18.8	19.6		
	No signal: Blackout (3 sec.)	51	53	20.0	20.8		
	No signal: Hold (3 sec.)	54	56	21.2	22.0		
	No signal: House Light (3 sec.)	57	59	22.4	23.1		
	No function	60	65	23.5	25.5		
	Flash style: Normal (3 sec.)	66	68	25.9	26.7		
	Flash style: Xenon (3 sec.)	69	71	27.1	27.8		
	Flash duration: Normal	72	74	28.2	29.0		
	Flash duration: Percentage	75	77	29.4	30.2		
	White Point: Off (RAW) (3 sec.)	78	80	30.6	31.4		
	White Point: 8000K (3 sec.)	81	83	31.8	32.6		
	White Point: 6500K (3 sec.)	84	86	32.9	33.8		
	White Point: 5600K (3 sec.)	87	89	34.1	34.9		
	No function	90	101	35.3	39.6		
	Fan mode: Regulated (3 sec.)	102	104	40.0	40.8		
	Fan mode: High (3 sec.)	105	107	41.2	42.0		
	Fan mode: Medium (3 sec.)	108	110	42.4	43.1		
	Fan mode: Low (3 sec.)	111	113	43.5	44.3		
	No function	114	116	44.7	45.5		
	Fixture Order. Normal (3 sec.)	117	119	45.9	46.7		
	Fixture Order. Reversed (3 sec.)	120	122	47.1	47.9		
	No function	123	140	48.2	54.9		
	Pixel Mirror: Off (3 sec.)	141	143	55.3	56.1		
	Pixel Mirror: x-mirror Strobes A+B (3 sec.)	144	146	56.5	57.3		
	Pixel Mirror: y-mirror Strobes A+B (3 sec.)	147	149	57.7	58.4		
	Pixel Mirror: x-y-mirror Strobes A+B (3 sec.)	150	152	58.8	59.6		
	Pixel Mirror: x-mirror Strobe A only (3 sec.)	153	155	60.0	60.8		
	Pixel Mirror: y-mirror Strobe A only (3 sec.)	156	158	61.2	62.0		
	Pixel Mirror: x-y-mirror Strobe A only (3 sec.)	159	161	62.4	63.1		
	Pixel Mirror: x-mirror Strobe B only (3 sec.)	162	164	63.5	64.3		
	Pixel Mirror: y-mirror Strobe B only (3 sec.)	165	167	64.7	65.5		
	Pixel Mirror: x-y-mirror Strobe B only (3 sec.)	168	170	65.9	66.7		
	No function	171	173	67.1	67.8		
	Background color: Override (3 sec.)	174	176	68.2	69.0		
	Background color: Crossfade (3 sec.)	177	179	69.4	70.2		
	Background color: Mix Color (3 sec.)	180	182	70.6	71.4		
	No function	183	185	71.8	72.6		

PWM 2700 Hz (5 sec.)	186	188	72.9	73.7
PWM 3000 Hz (5 sec.)	189	191	74.1	74.9
PWM 4800 Hz (5 sec.)	192	194	75.3	76.1
PWM 9600 Hz (5 sec.)	195	197	76.5	77.3
No function	198	209	77.7	82.0
Save as Settings Preset 1 (move directly from zero, 5 sec.)	210	212	82.4	83.1
Save as Settings Preset 2 (move directly from zero, 5 sec.)	213	215	83.5	84.3
Save as Settings Preset 3 (move directly from zero, 5 sec.)	216	218	84.7	85.5
No function	219	221	85.9	86.7
Load Settings Preset 1 (3 sec.)	222	224	87.1	87.8
Load Settings Preset 2 (3 sec.)	225	227	88.2	89.0
Load Settings Preset 3 (3 sec.)	228	230	89.4	90.2
Load Settings Default (3 sec.)	231	233	90.6	91.4
No function	234	251	91.8	98.4
Reboot fixture (3 sec.)	252	255	98.8	100

To reduce the risk of accidentally changing settings, the commands on the Control / Settings channel must be held for a certain time before they are executed. The above table indicates the number of seconds that you must hold a command.

-GLP-